

4MP Vandal-resistant Network IR Fixed Dome Camera

IPC324LR3-VSPF28(40)-D



Key Features

Optics

- Day/night functionality
- Smart IR, up to 30 m (98 ft) IR distance
- 2D/3D DNR (Digital Noise Reduction)

Compression

- Ultra 265, H.265, H.264, MJPEG
- Triple streams
- ROI (Region of Interest)

Network

- ONVIF Conformance

Structure

- Wide temperature range: -30°C to 60°C (-22°F to 140°F)
- Wide voltage range of $\pm 25\%$
- IK10 vandal resistant
- IP67
- 2-Axis

Specifications

	IPC324LR3-VSPF28-D	IPC324LR3-VSPF40-D			
Camera					
Sensor	1/3", progressive scan, 4.0 megapixel, CMOS				
Lens	2.8mm@F2.0		4.0mm@ F2.0		
DORI Distance	Lens	Detect(m)	Observe(m)	Recognize(m)	Identify(m)
	2.8mm	42	16.8	8.4	4.2
	4.0mm	60	24	12	6
Angle of View (H)	104.4°		78.9°		
Angle of View (V)	54.4°		39.6°		
Angle of View (O)	135.7°		97.0°		
Adjustment angle	Pan: 0°~360°		Tilt: 0°~75°		
Shutter	Auto/Manual, 1~1/100000 s				
Minimum Illumination	Colour: 0.03 Lux (F2.0, AGC ON) 0Lux with IR				
Day/Night	IR-cut filter with auto switch (ICR)				
Digital noise reduction	2D/3D DNR				
S/N	>52dB				
IR Range	Up to 30m (98 ft) IR range				
Defog	Digital Defog				
WDR	DWDR				
Video					
Video Compression	Ultra 265,H.265,H.264,MJPEG				
H.264 code profile	Baseline profile, Main Profile, High Profile				
Frame Rate	Main Stream:4MP (2592*1520): Max. 20 fps; Sub Stream:720P (1280*720): Max. 20 fps; Third Stream:D1 (720*576): Max. 20 fps				
HLC	Supported				
BLC	Supported				
OSD	Up to 4 OSDs				
Privacy Mask	Up to 8 areas				
ROI	Up to 2 areas				
Motion Detection	Up to 4 areas				
Network					
Protocols	IPv4,IGMP,ICMP,ARP,TCP,UDP,DHCP, RTP,RTSP,RTCP,DNS,DDNS,NTP,FTP,UPnP,HTTP,HTTPS,SMTP, SSL				
Compatible Integration	ONVIF(Profile S, Profile T), API				
Interface					
Network	1 RJ45 100M Base-TX Ethernet				
General					
Power	DC12V±25%, PoE (IEEE802.3 af)				
	Power consumption: Max.4w				
Dimensions (Ø x H)	Ø109 x 81mm (Ø5.8" x 4.4")				

Weight	0.35kg (0.77lb)
Working Environment	-30°C ~ +60°C (-22°F ~ 140°F), Humidity :10%~90% RH(non-condensing)
Ingress Protection	IP67
Vandal Resistant	IK10

Dimensions

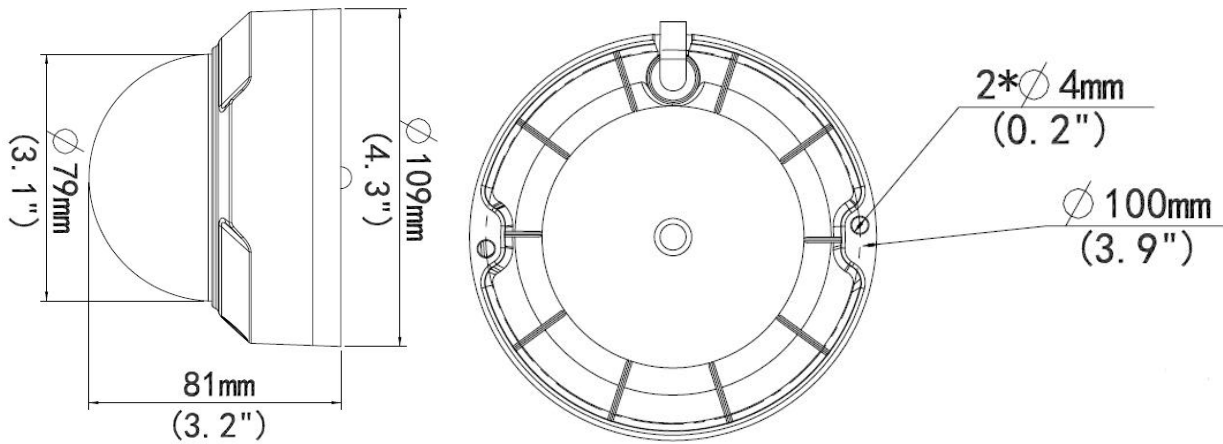

Zhejiang Uniview Technologies Co., Ltd.

Building No.10, Wanlun Science Park, Jiangling Road 88, Binjiang District, Hangzhou, Zhejiang, China (310051)

Email: overseasbusiness@uniview.com; globalsupport@uniview.com

<http://www.uniview.com>

©2018 Zhejiang Uniview Technologies Co., Ltd. All rights reserved.

*Product specifications and availability are subject to change without notice.