

ИНФО ФАЙЛ ПОЛКИ СВ/У/К



Схема установки полок в шкаф



СОВМЕСТИМОСТЬ ПОЛОК СО ШКАФАМИ ЦМО				
ПОЛКА	ШТК-М 4X.6.6	ШТК-М 4X.6.8	ШТК-М 4X.6.10	ШТК-С 4X.6.10
СВ-39/-9005	ДА	ДА	ДА	ДА
СВ-45/-9005	ДА	ДА	ДА	ДА
СВ-45У/-9005				
СВ-45АК/-9005				
СВ-58/-9005	НЕТ	ДА	ДА	ДА
СВ-58У/-9005				
СВ-58АК/-9005				
СВ-62/-9005	НЕТ	ДА	ДА	ДА
СВ-62У/-9005				
СВ-62АК/-9005				
СВ-75/-9005	НЕТ	НЕТ	ДА	ДА
СВ-75У/-9005				
СВ-75АК/-9005				
СВ-100/-9005	НЕТ	НЕТ	НЕТ	ДА
СВ-100У/-9005				
СВ-100АК/-9005				

Шкаф = 105,589 кб. м		Имя файла модели		INFO_SV_SCHKAFI		
Сборки= 0,000 мм		Имя файла чертежа		D_INFO_SV_SHKAFI		
ИНФО ПОЛКИ СВ/У/АК УСТАНОВКА В ШКАФ СБ						
Изм	Лист	№ док.м.	Подп.	Дата	Лист	Масса
Разраб.				14.03.18	0	554,658
Проб.						1:20
Т.контр.					Лист 1	Листов 5
Н.контр.					ЦМО	
Утв.						

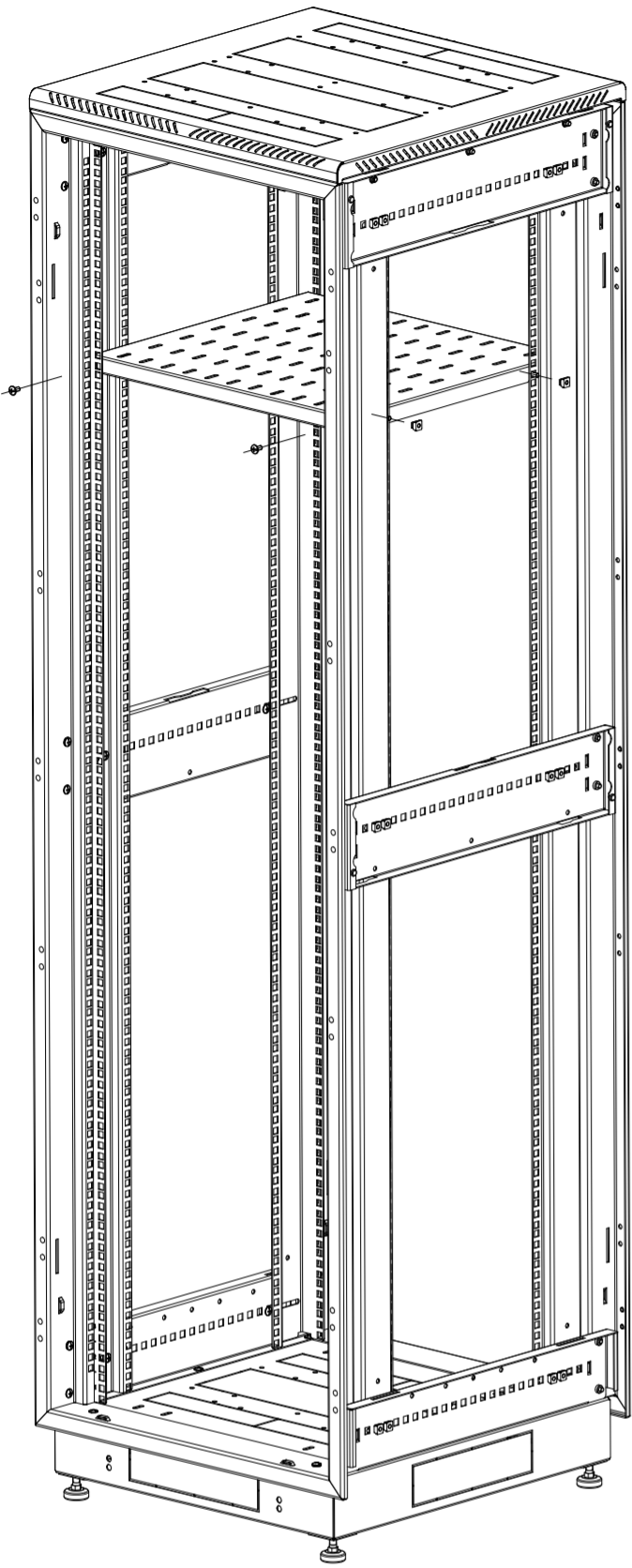
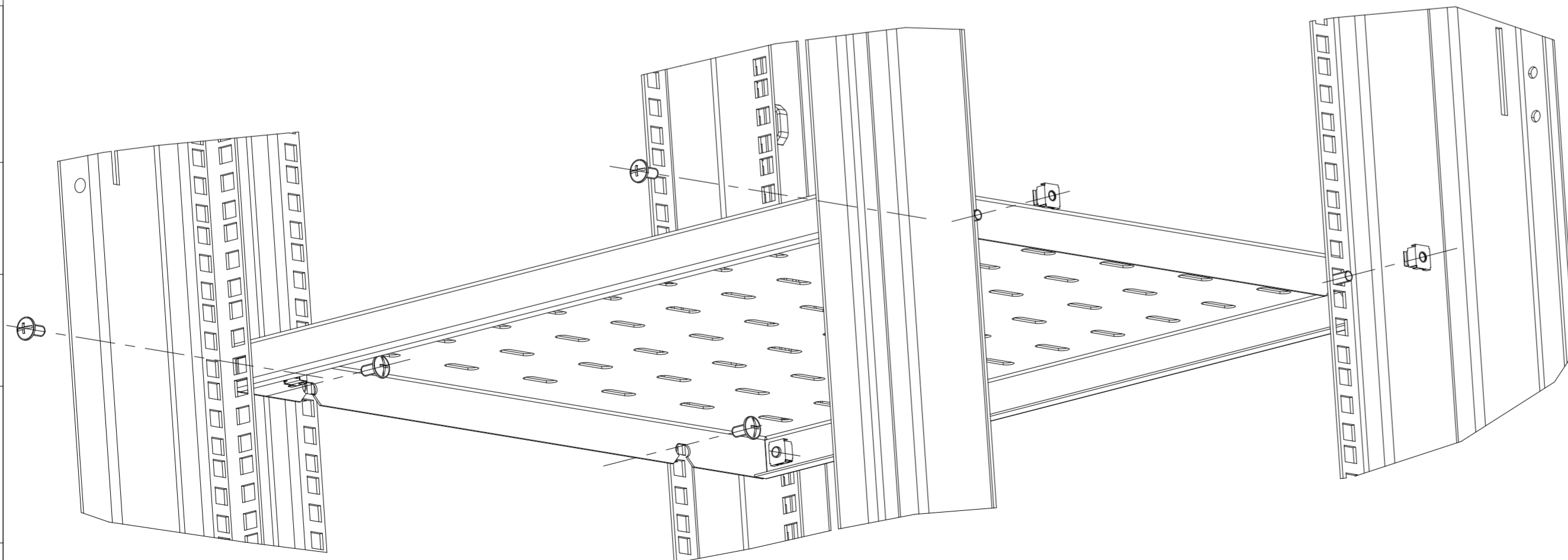
Перв. примен.
Справ. N

Подл. и дата
Инв.№ дубл.
Взам.инв.№
Подл. и дата
Инв.№ подл.

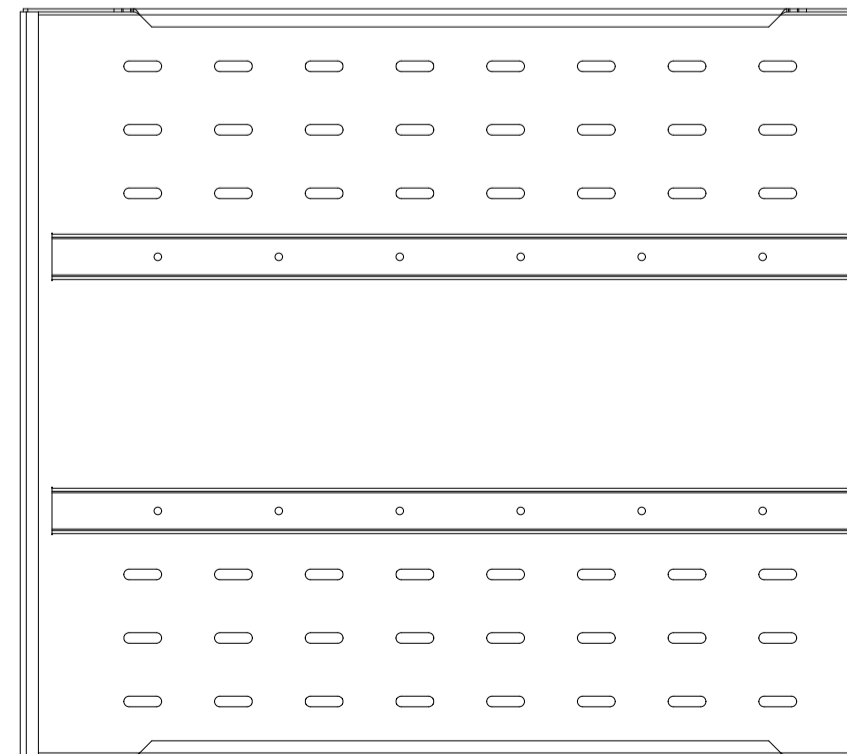
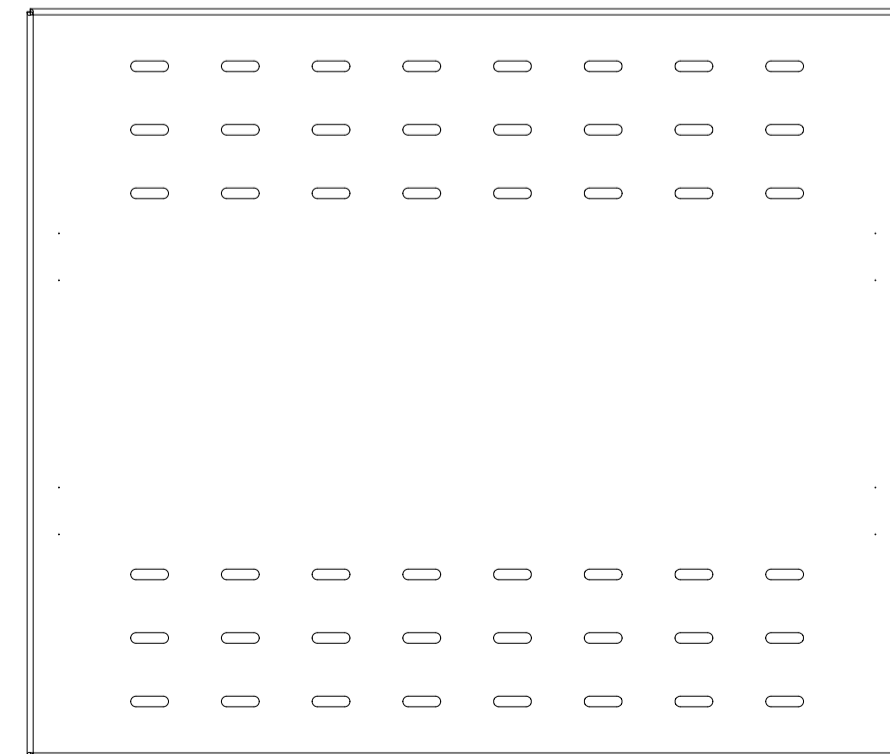
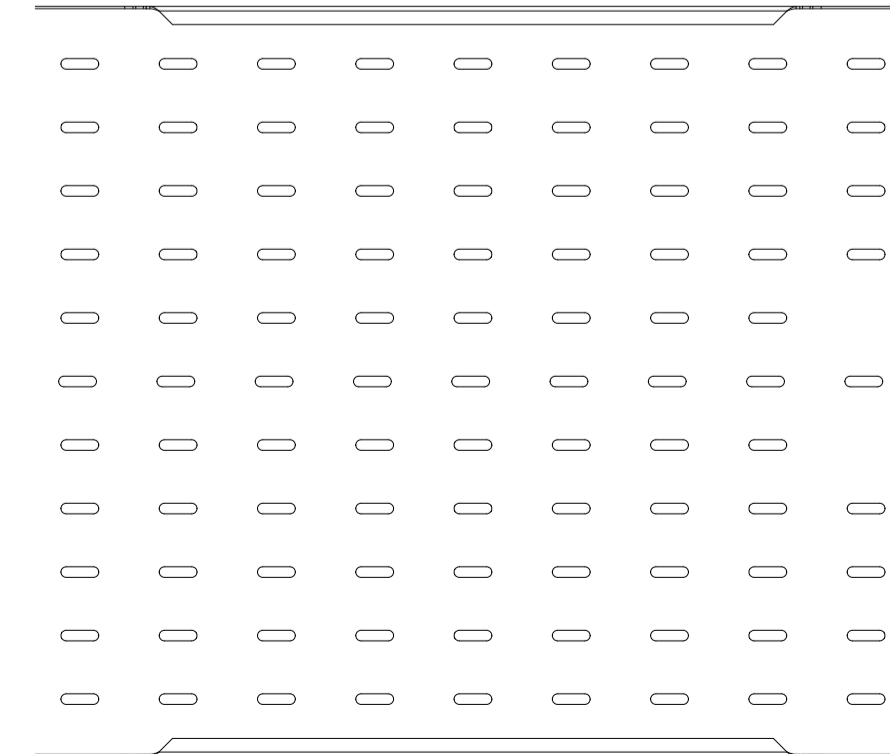
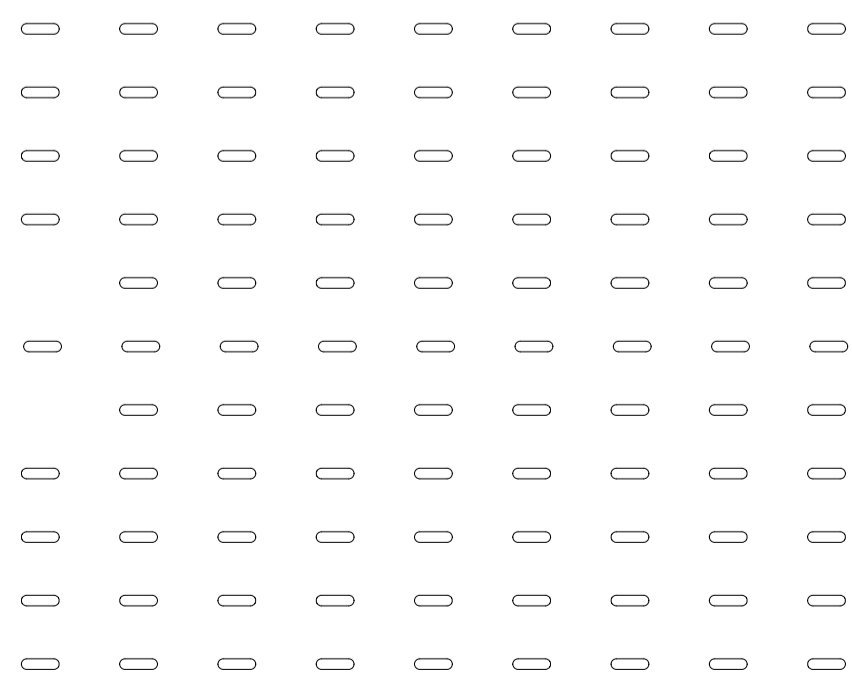
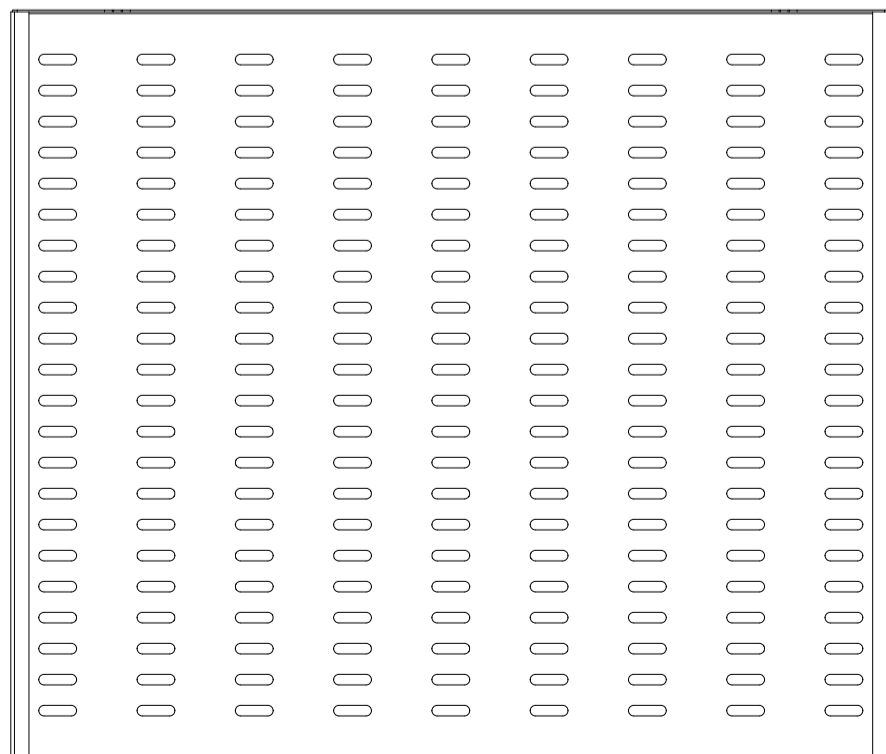
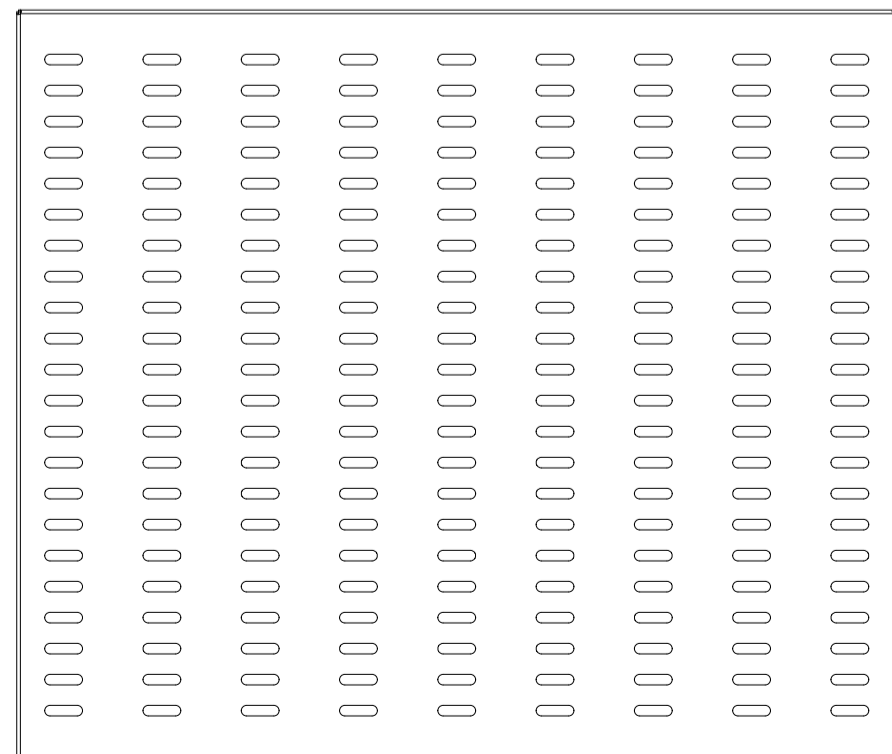
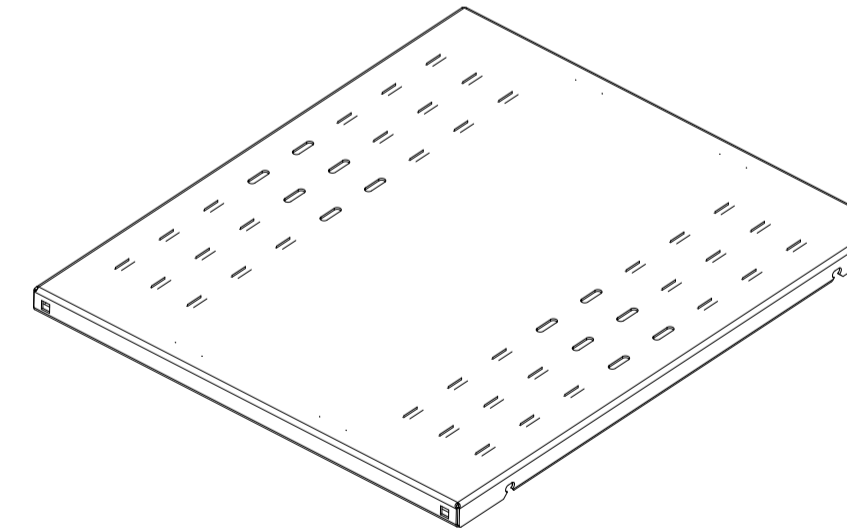
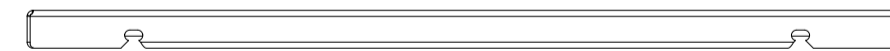
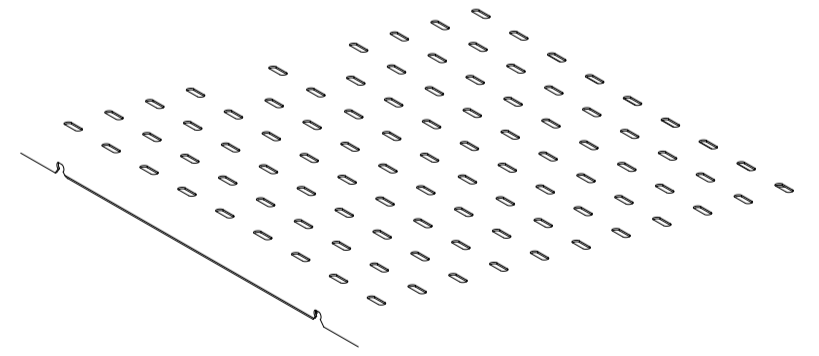
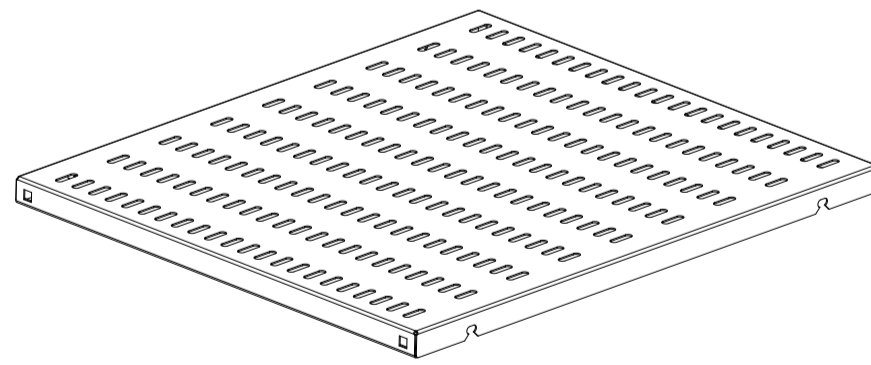
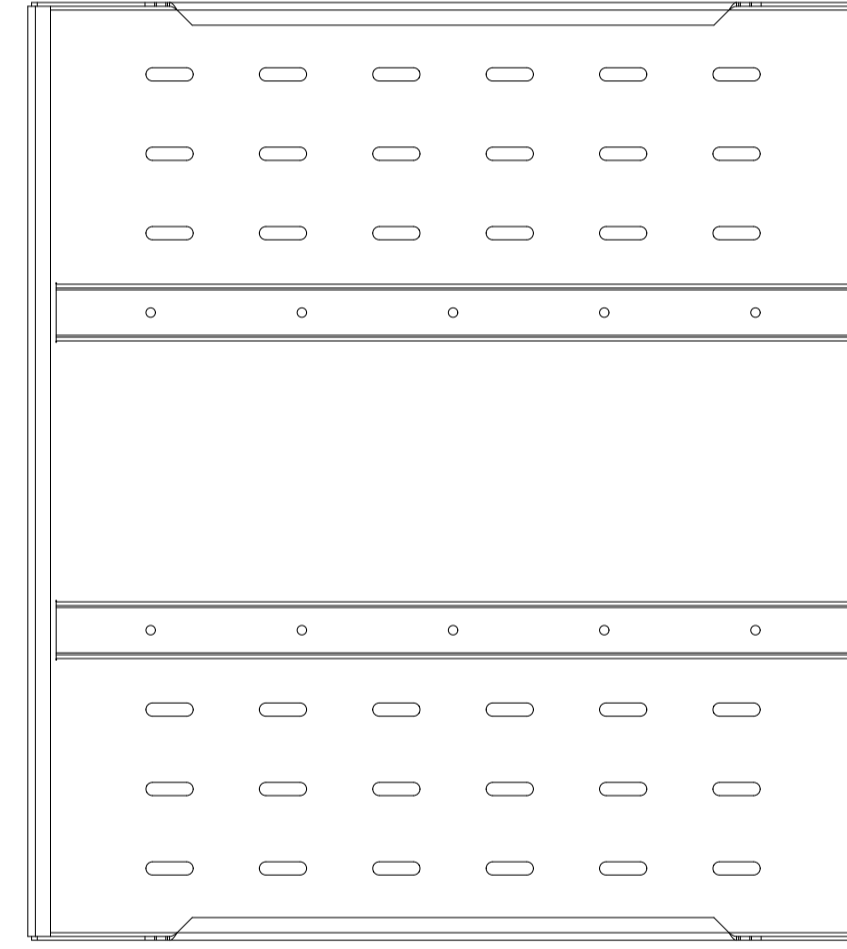
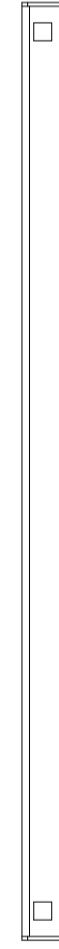
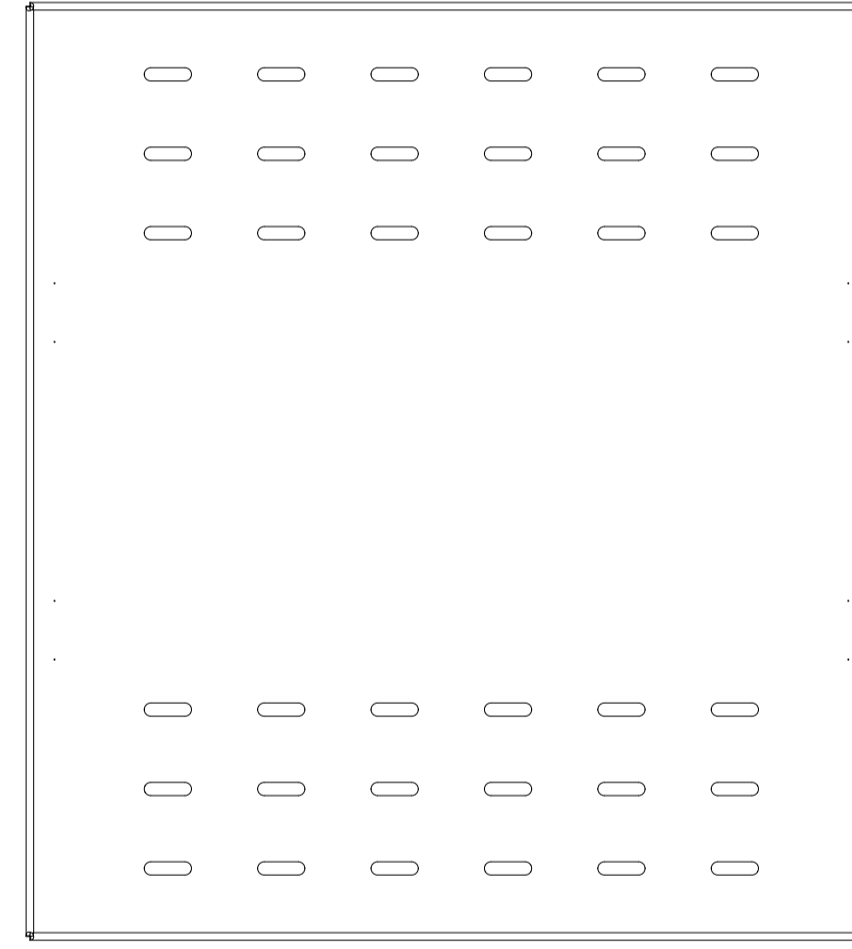
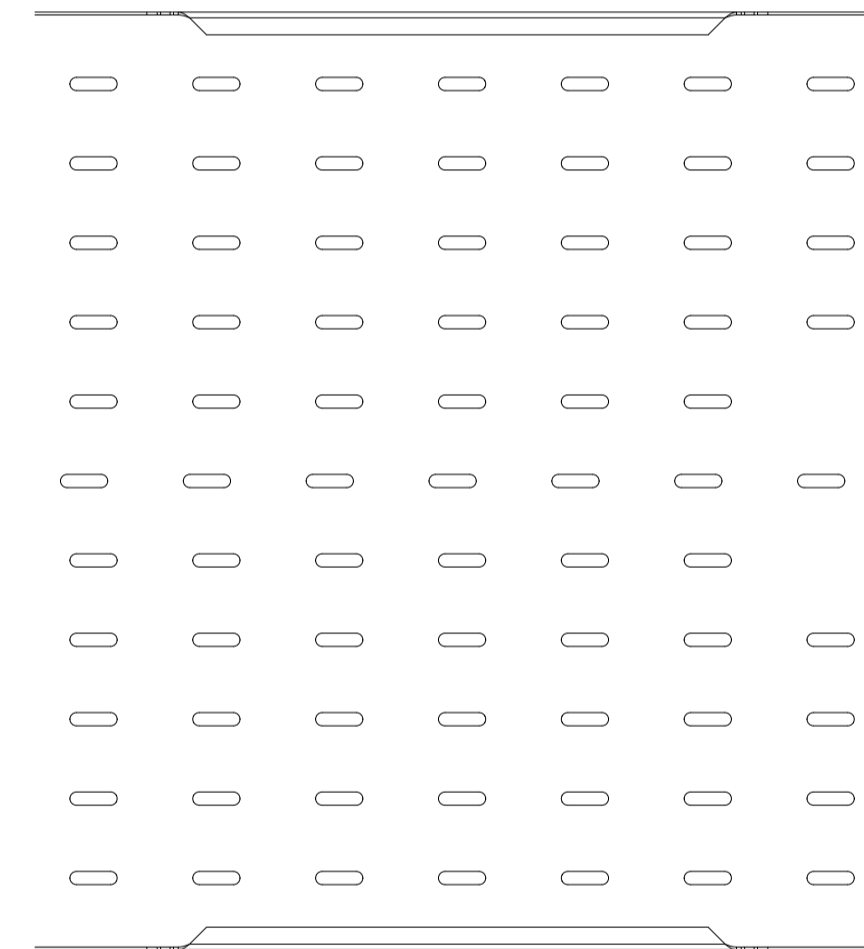
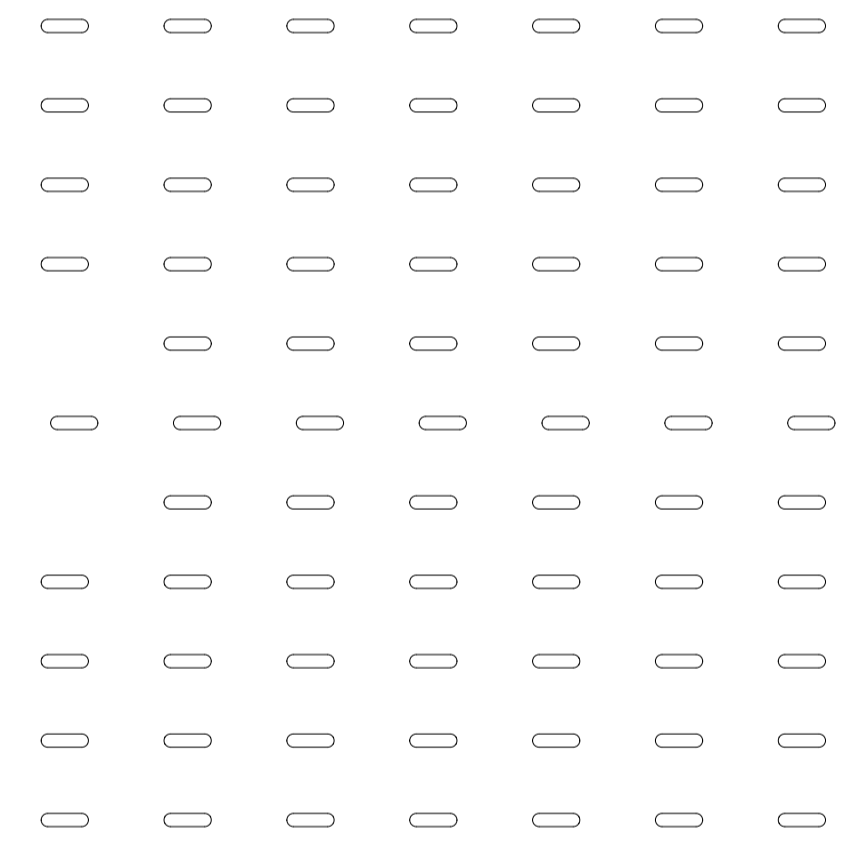
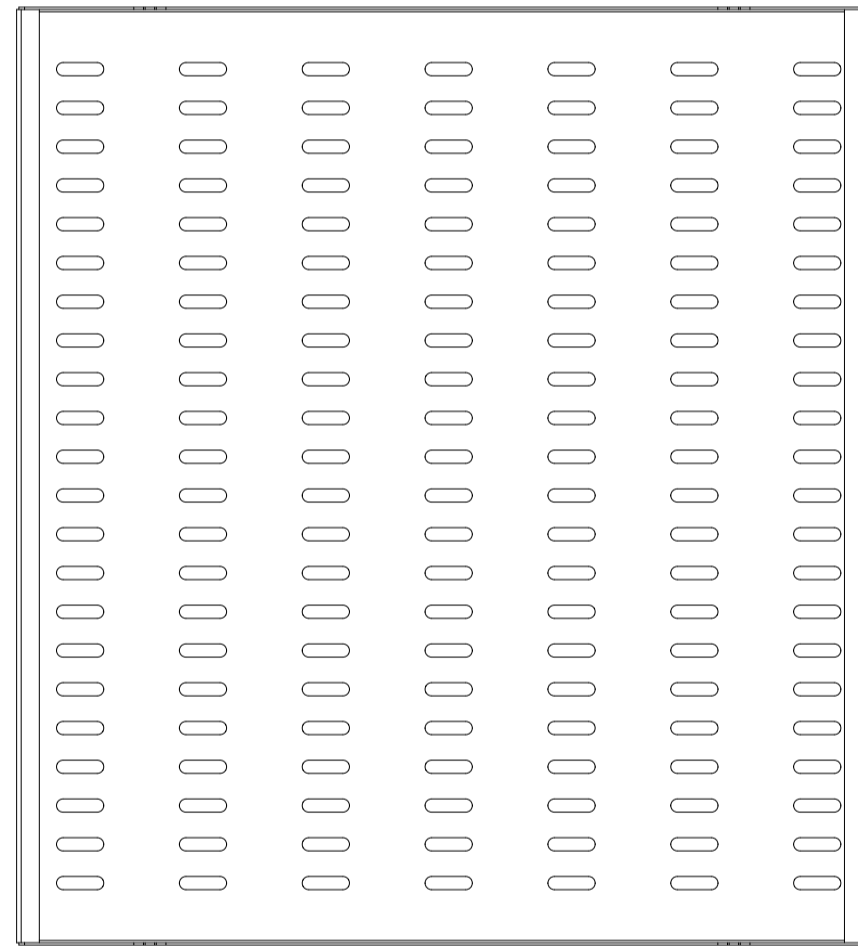
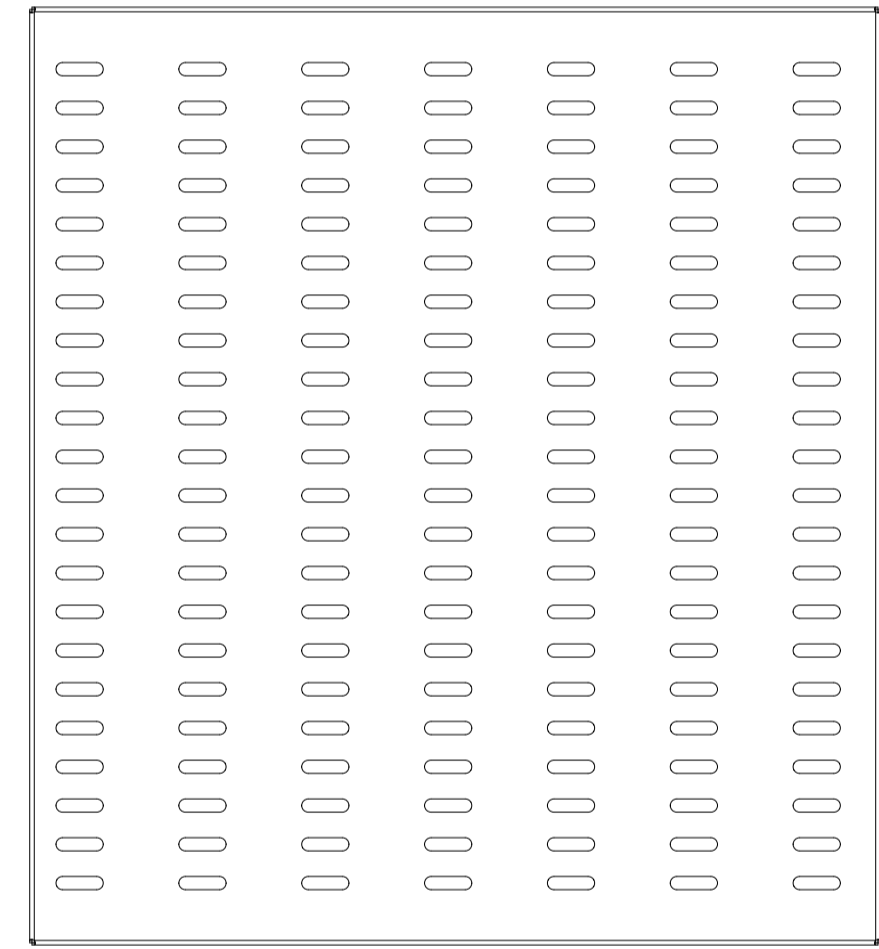
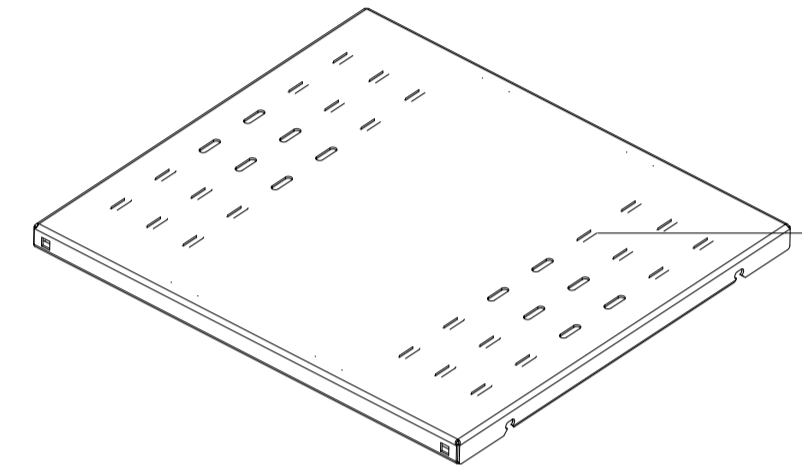
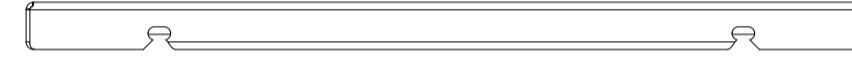
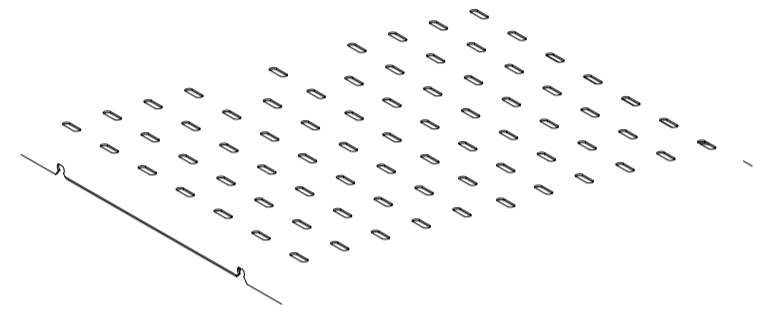
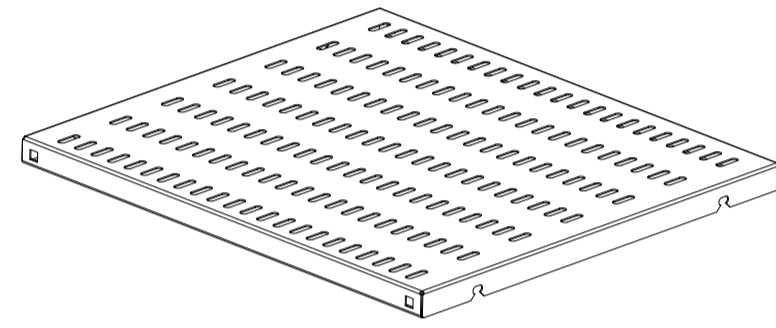
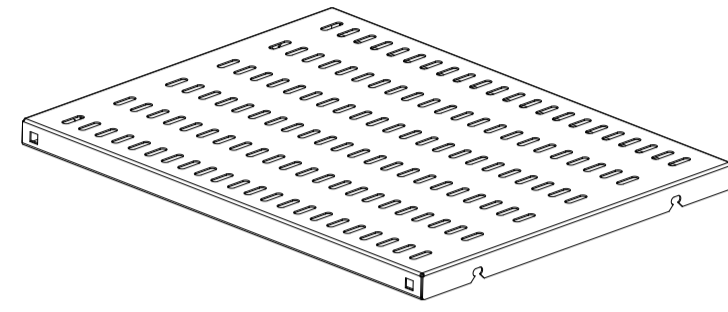
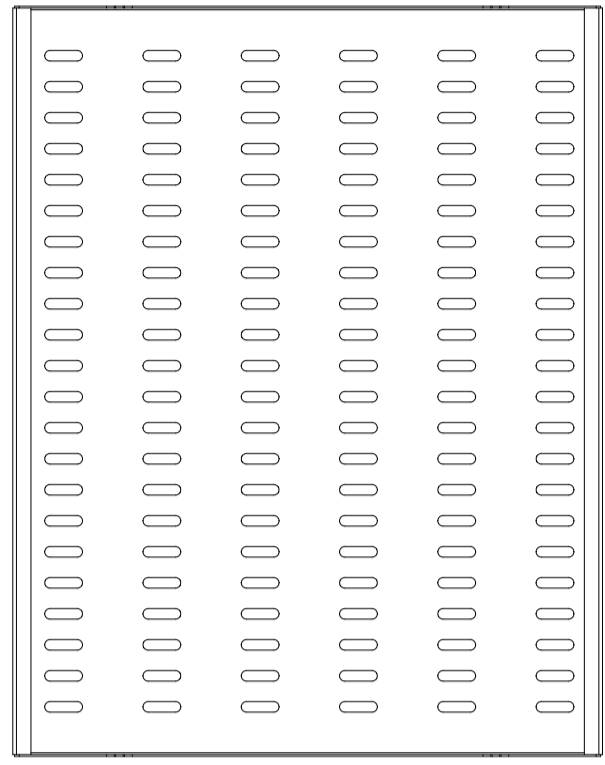
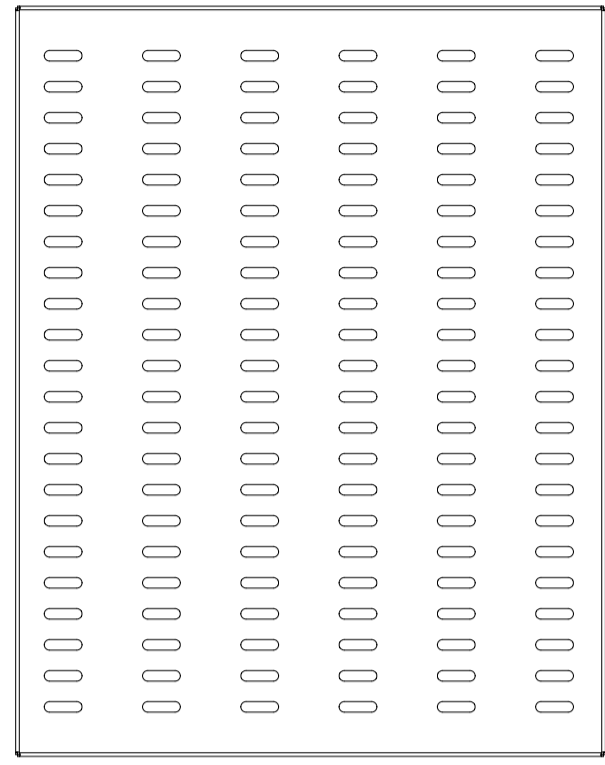

ПОЛКА СВ-62

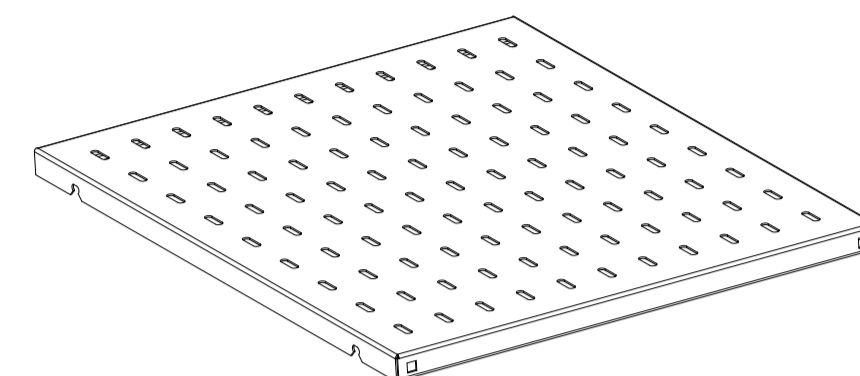
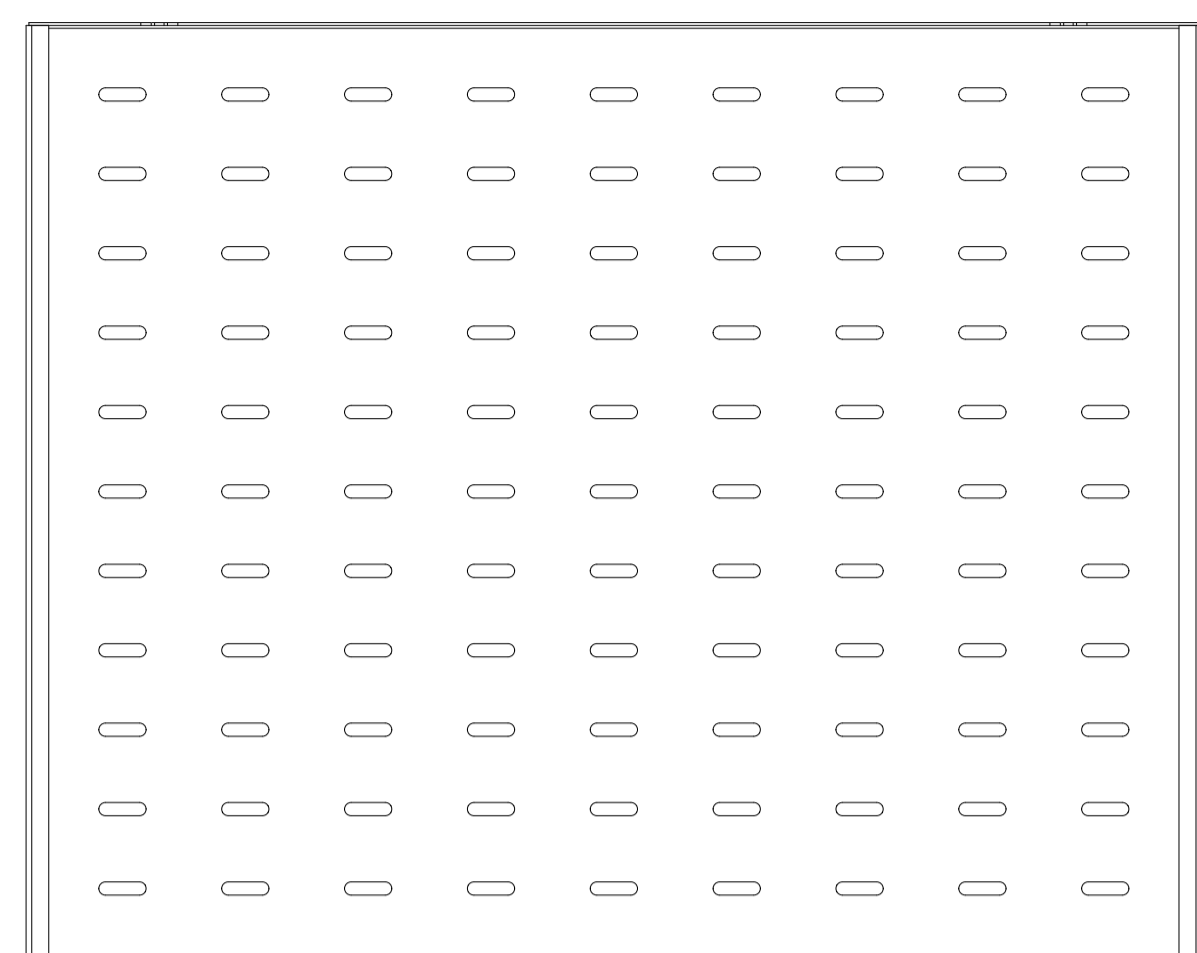
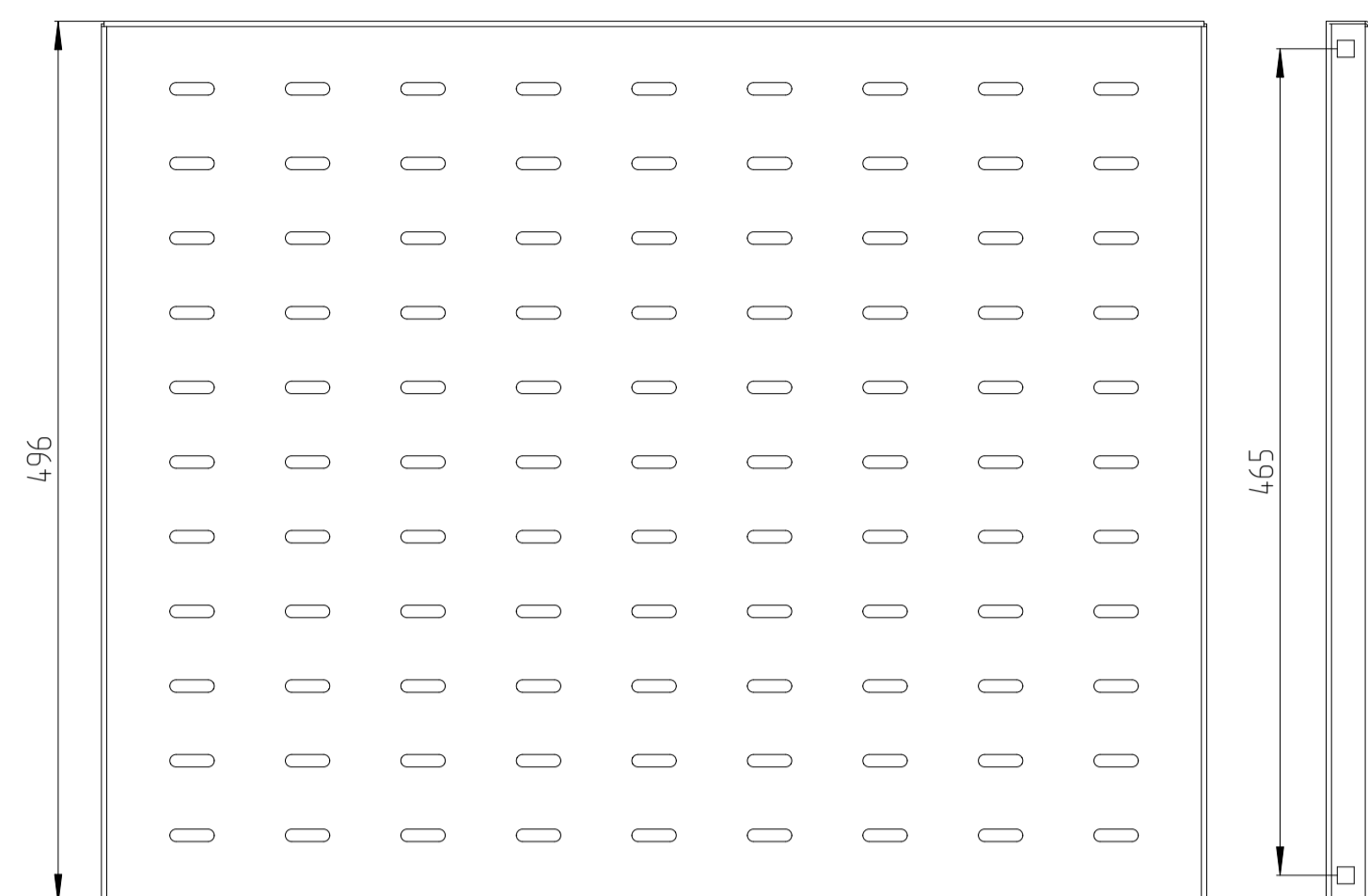
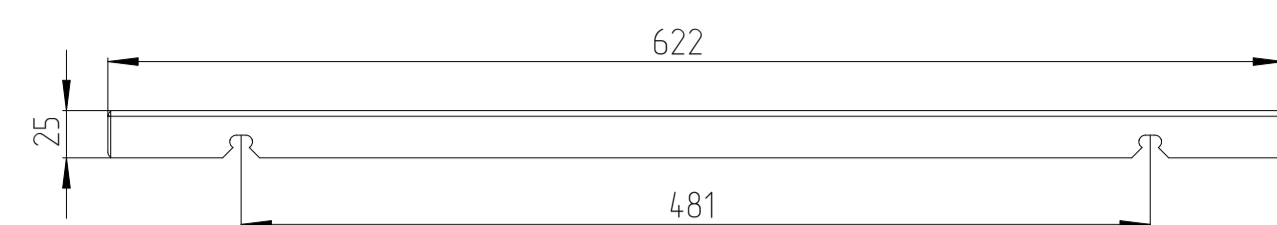

ПОЛКА СВ-62У

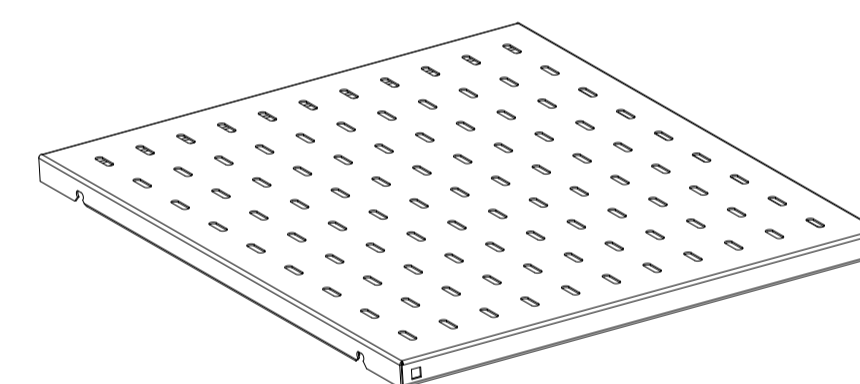
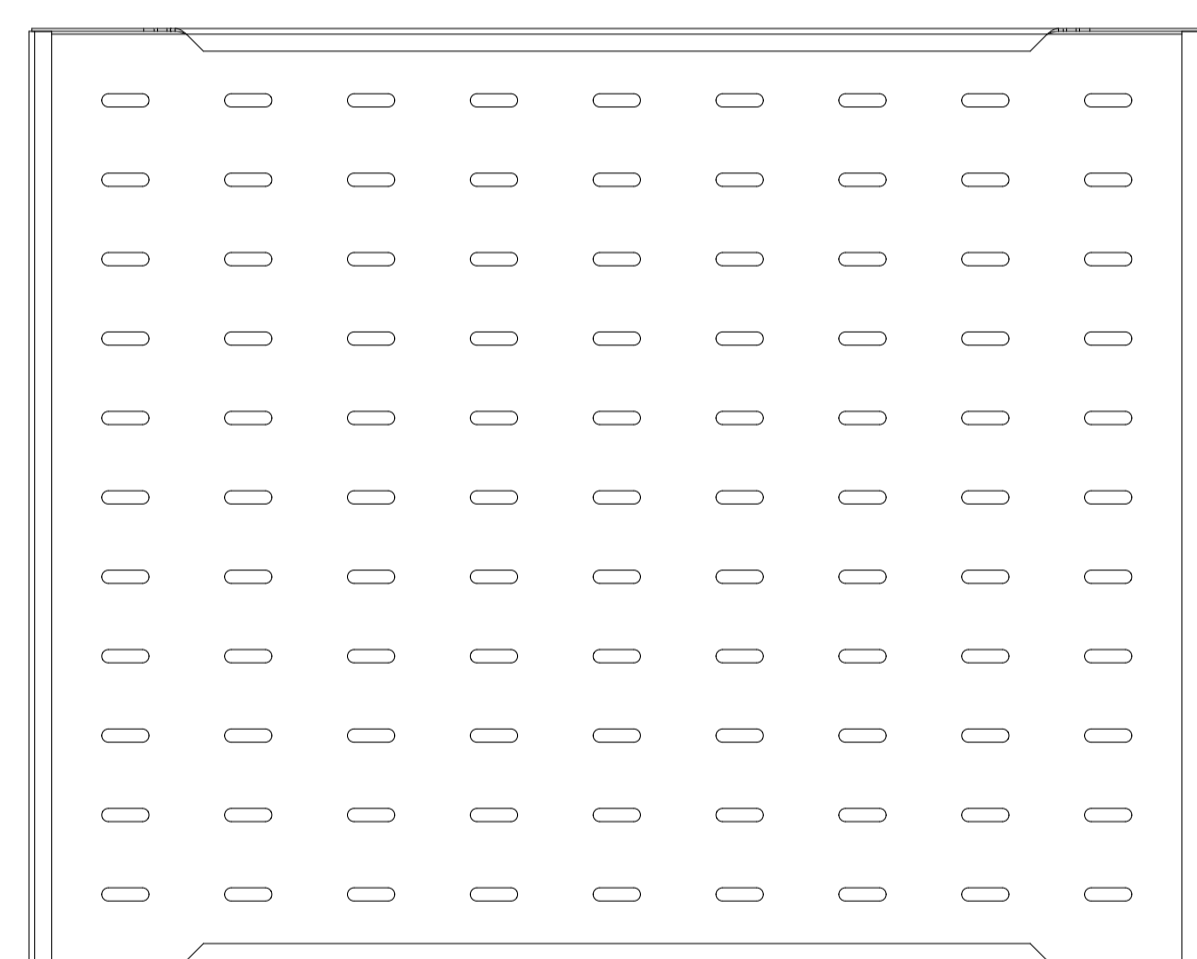
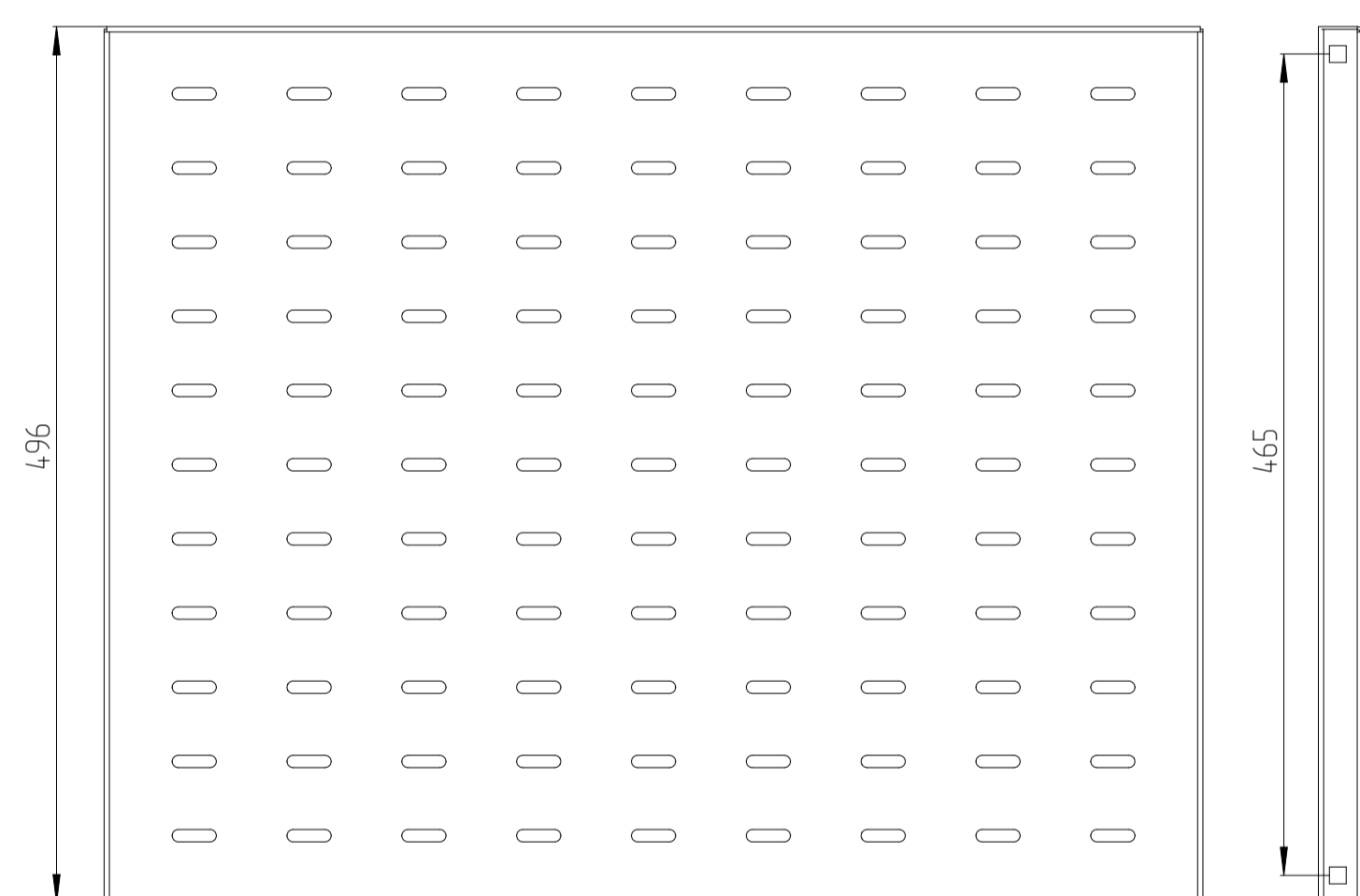
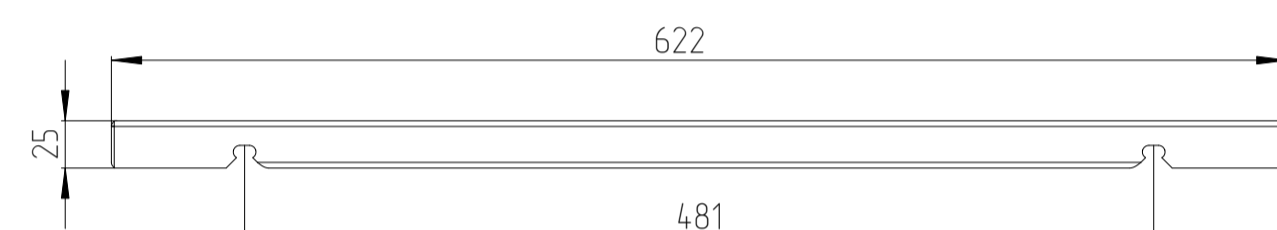

ПОЛКА СВ-62АК

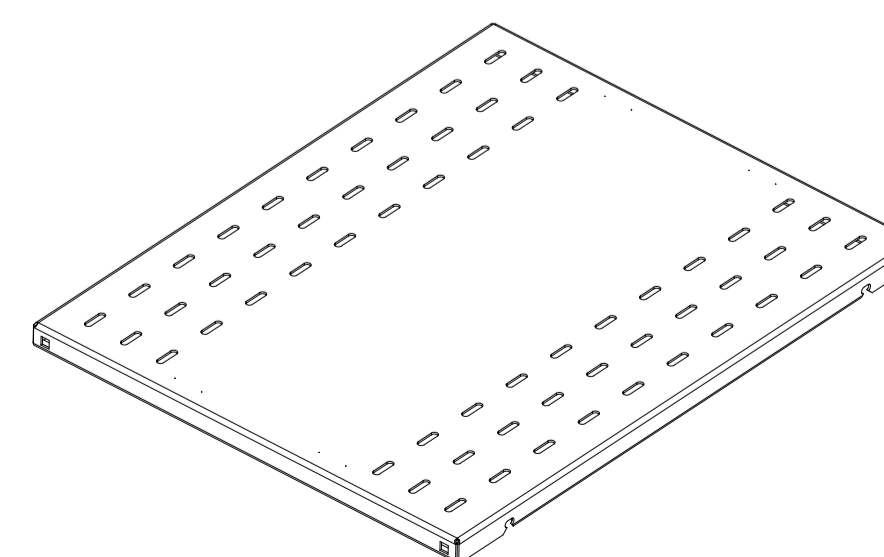
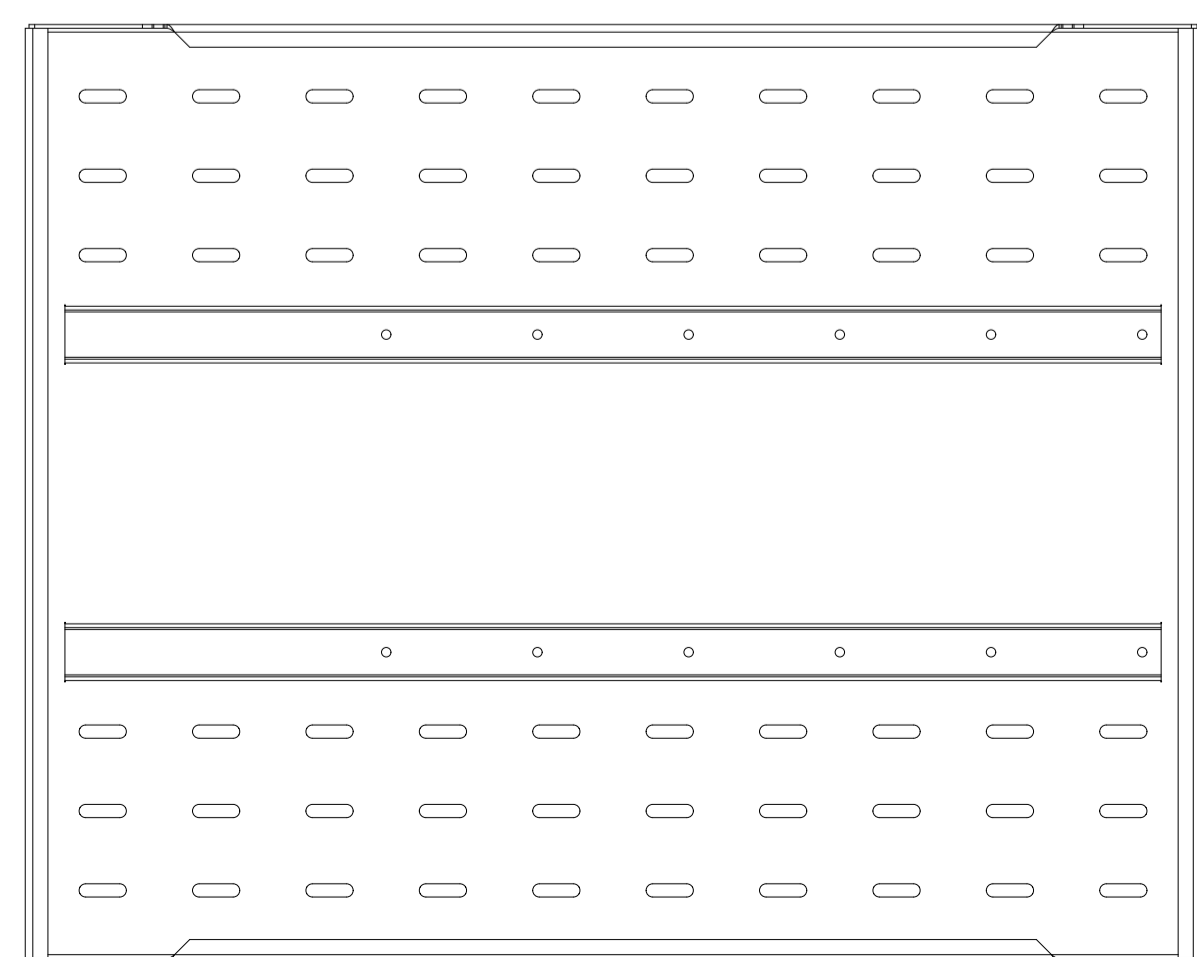
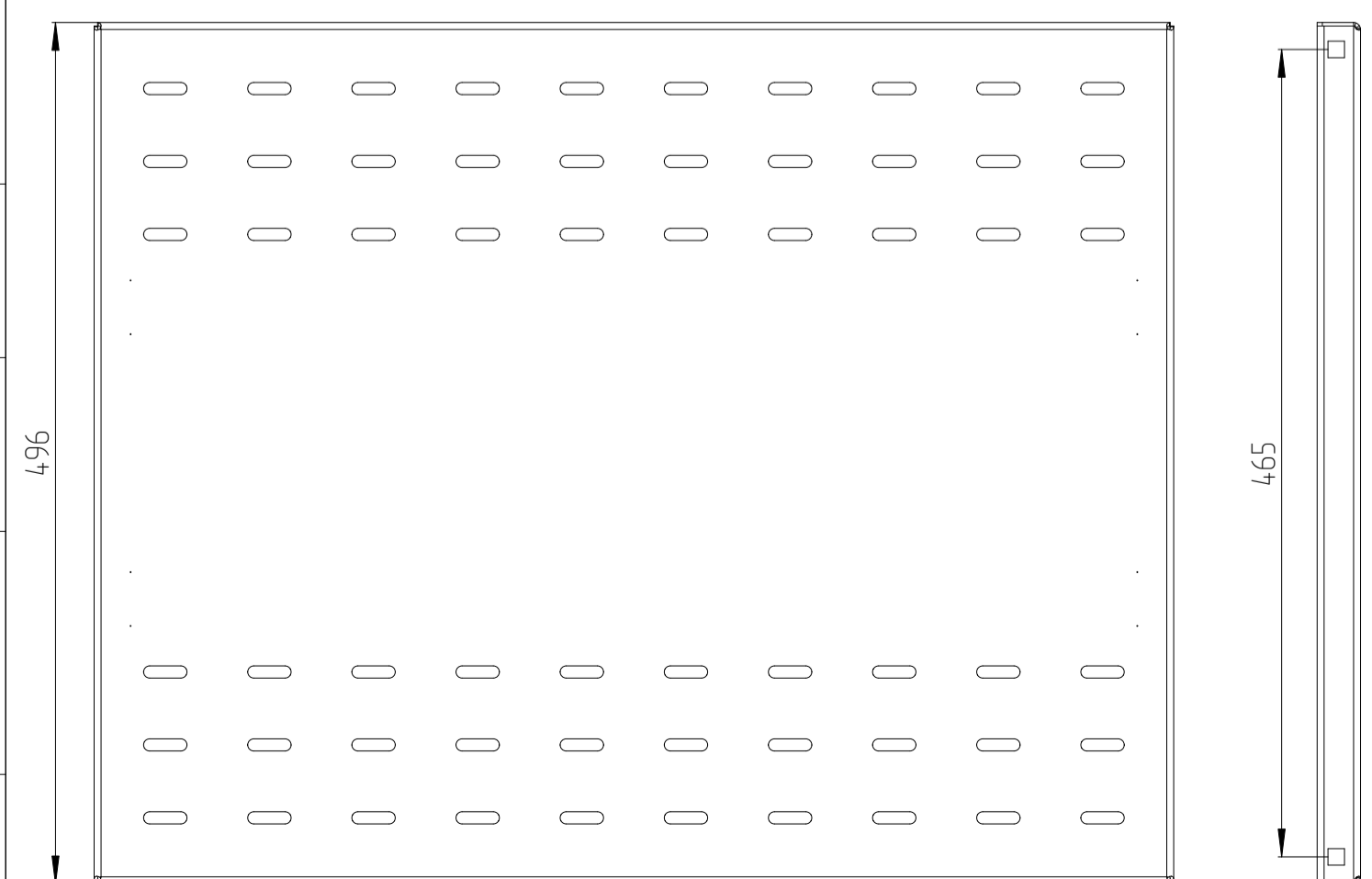
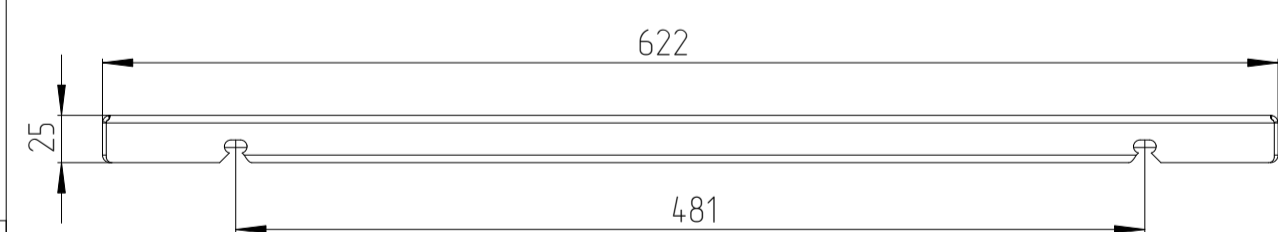

ПОЛКА СВ-75

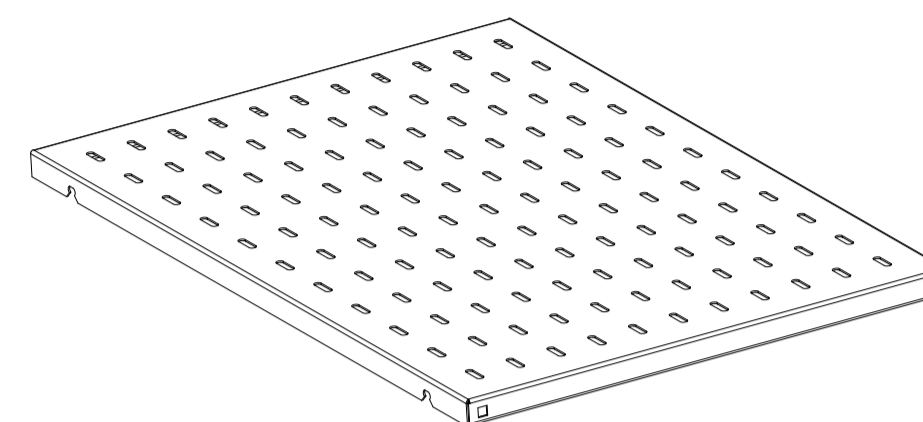
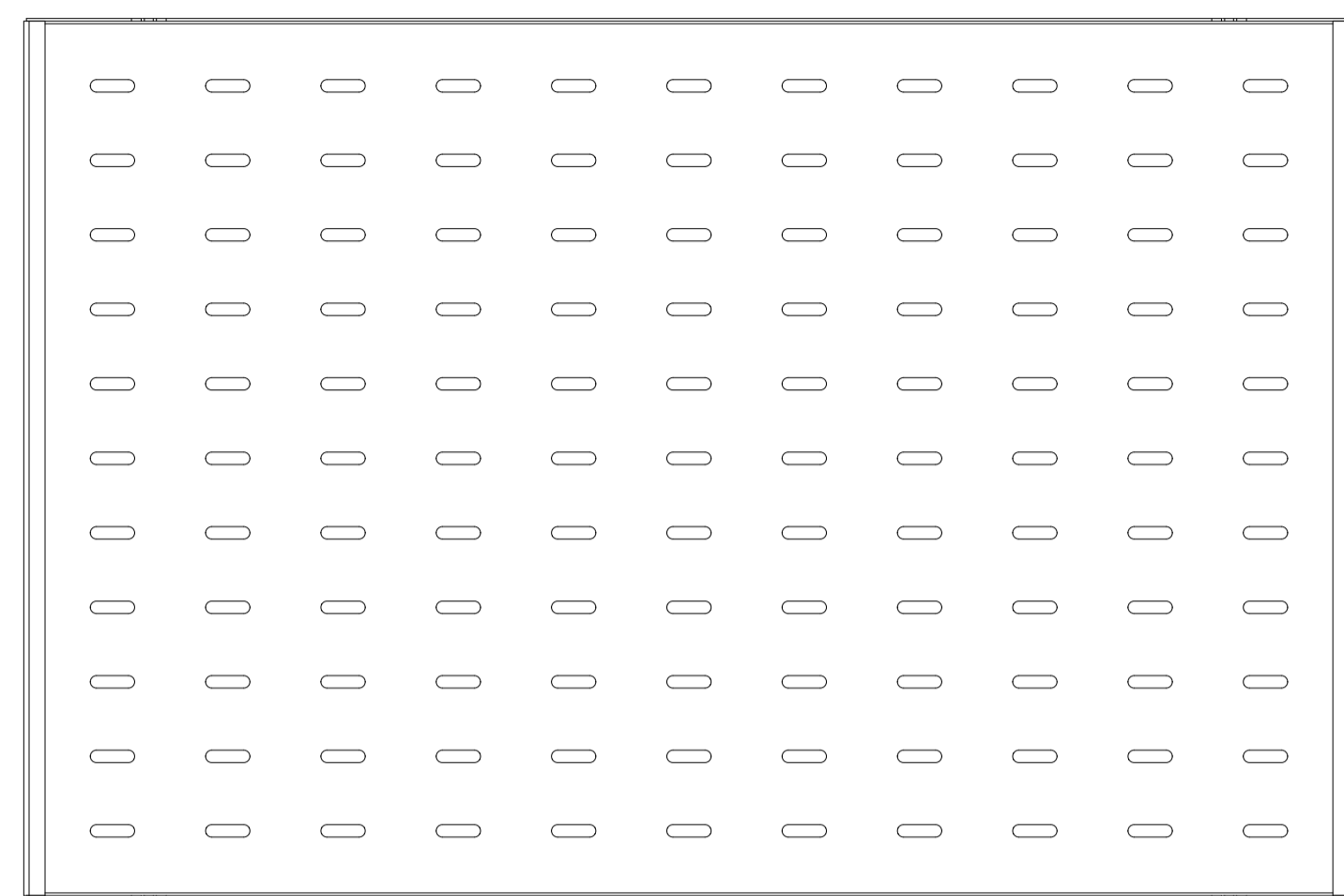
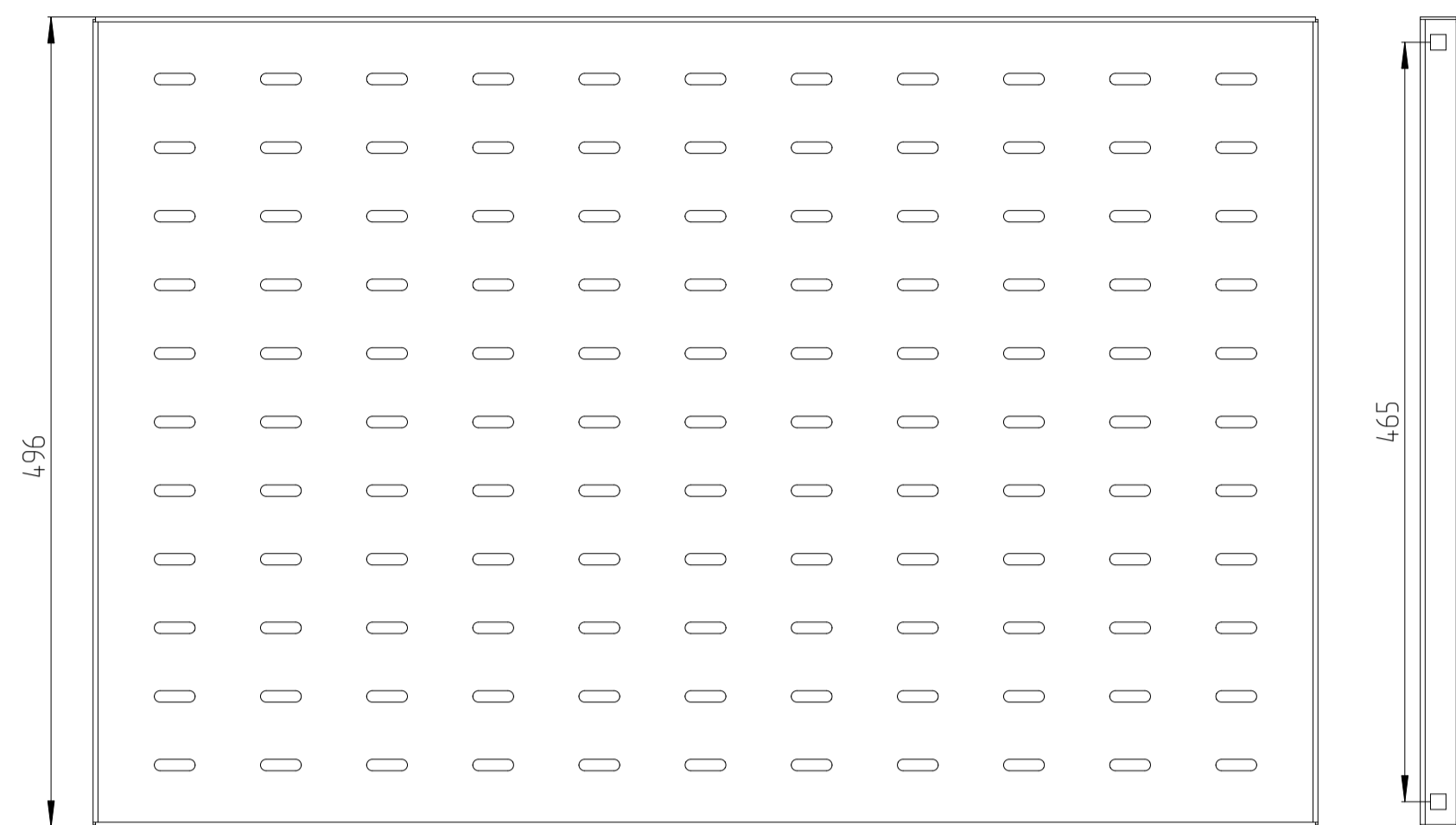
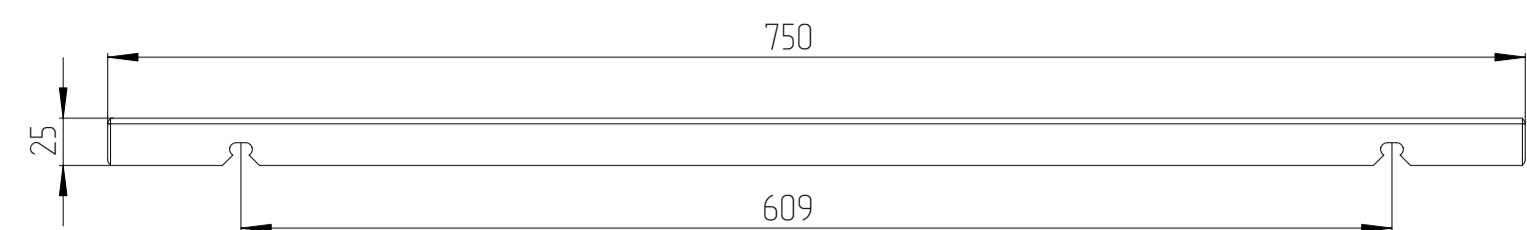

ПОЛКА СВ-75У

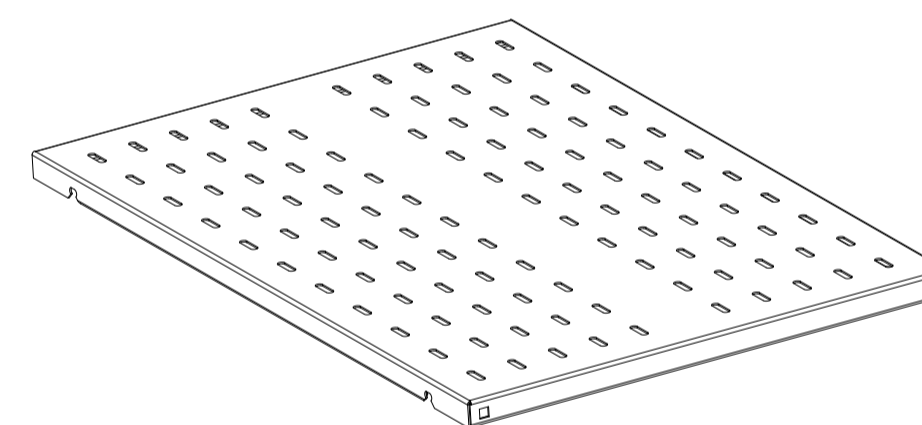
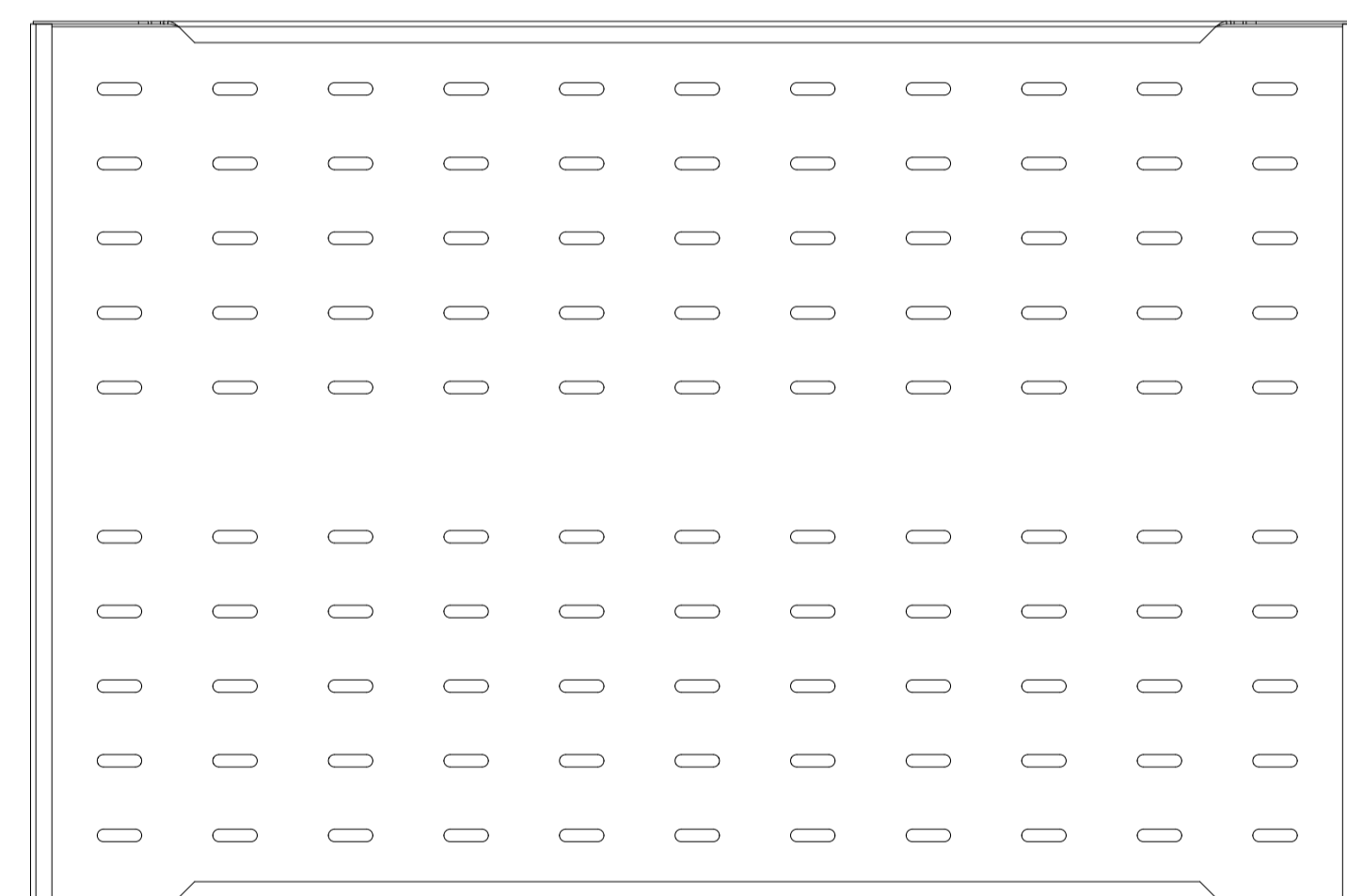
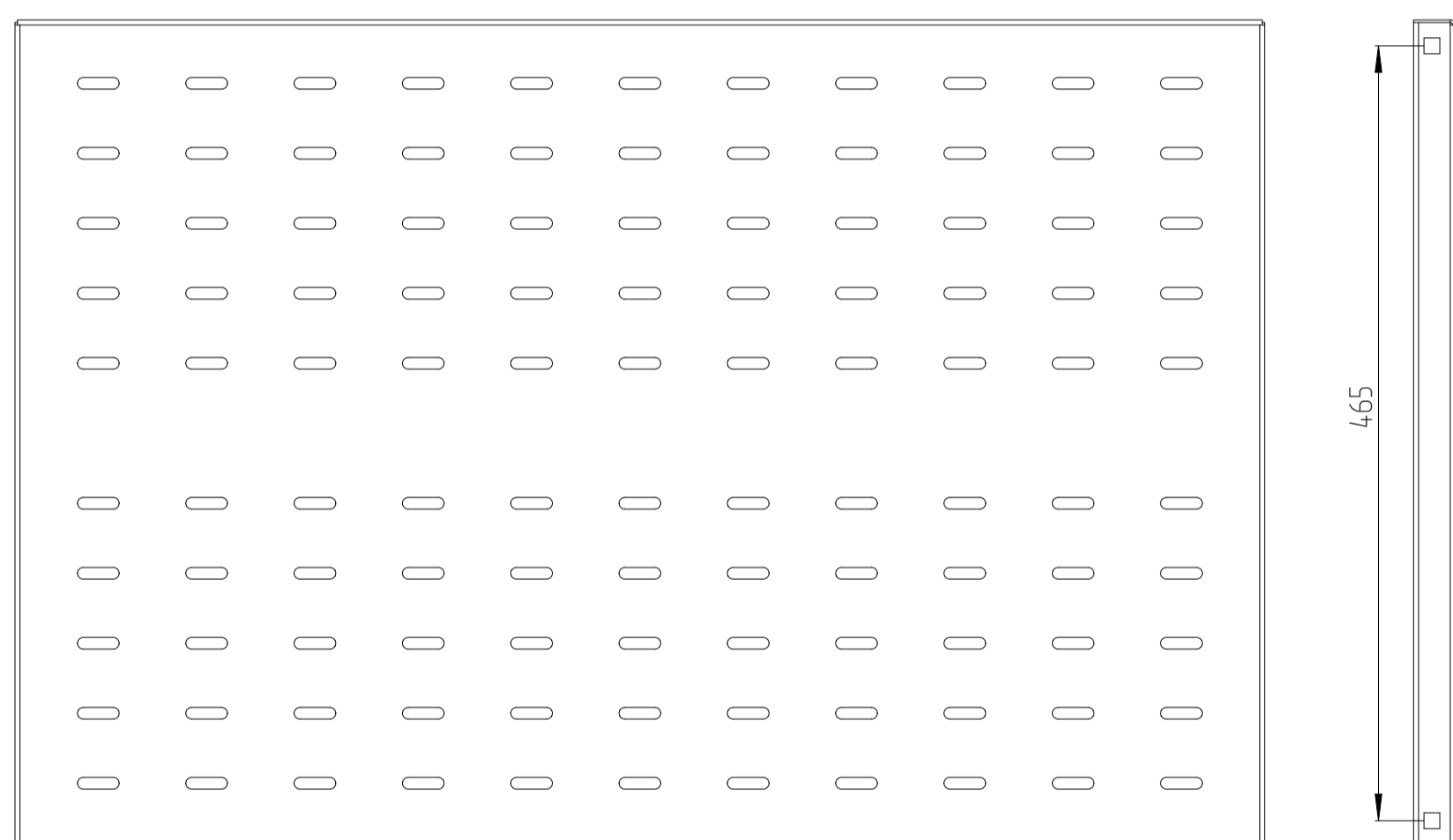
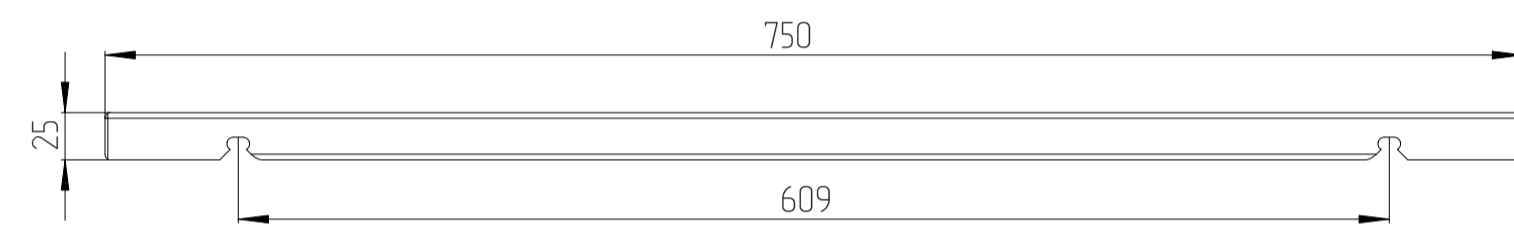

ПОЛКА СВ-75АК

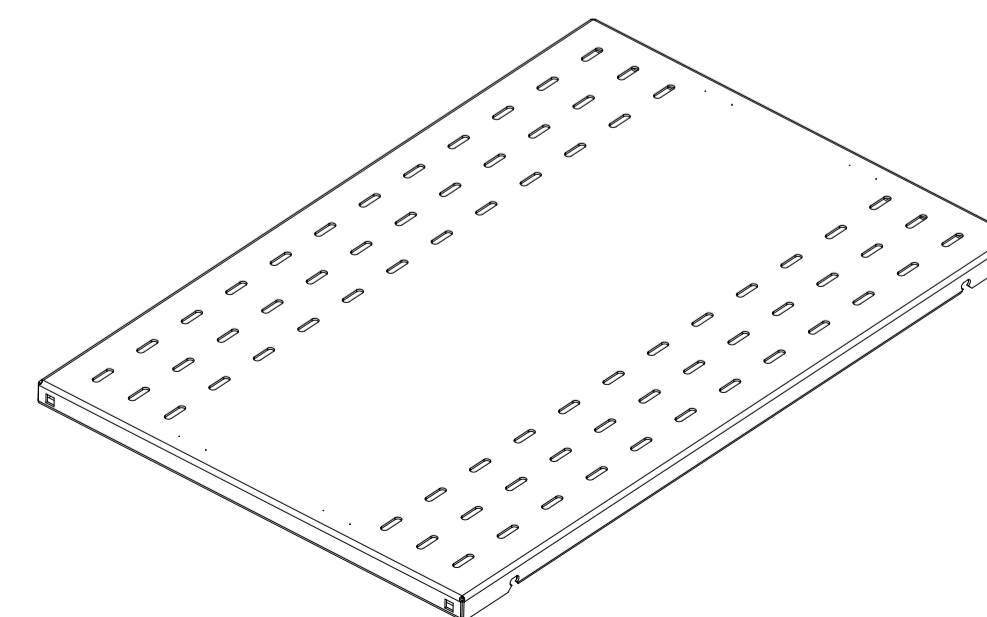
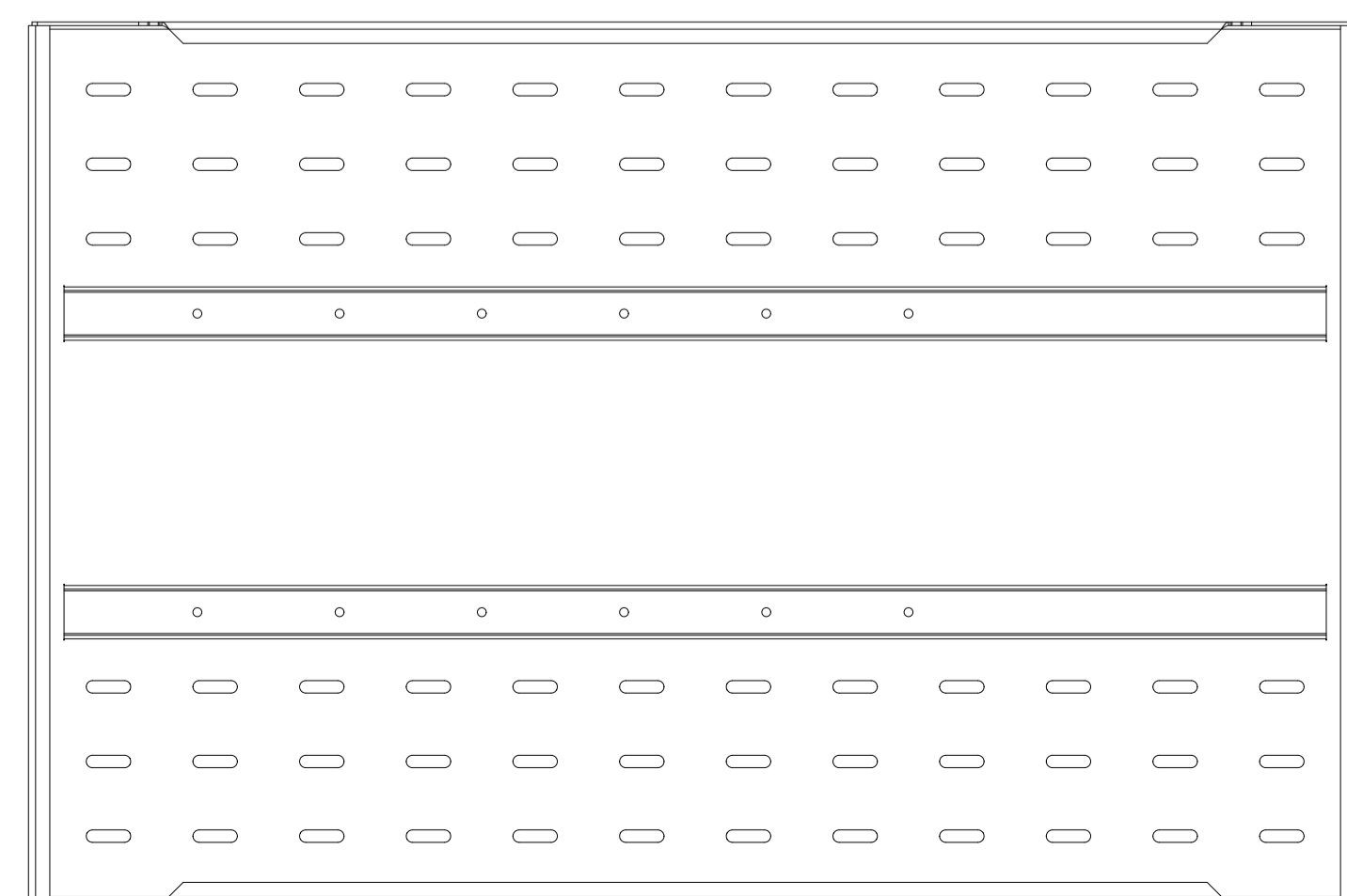
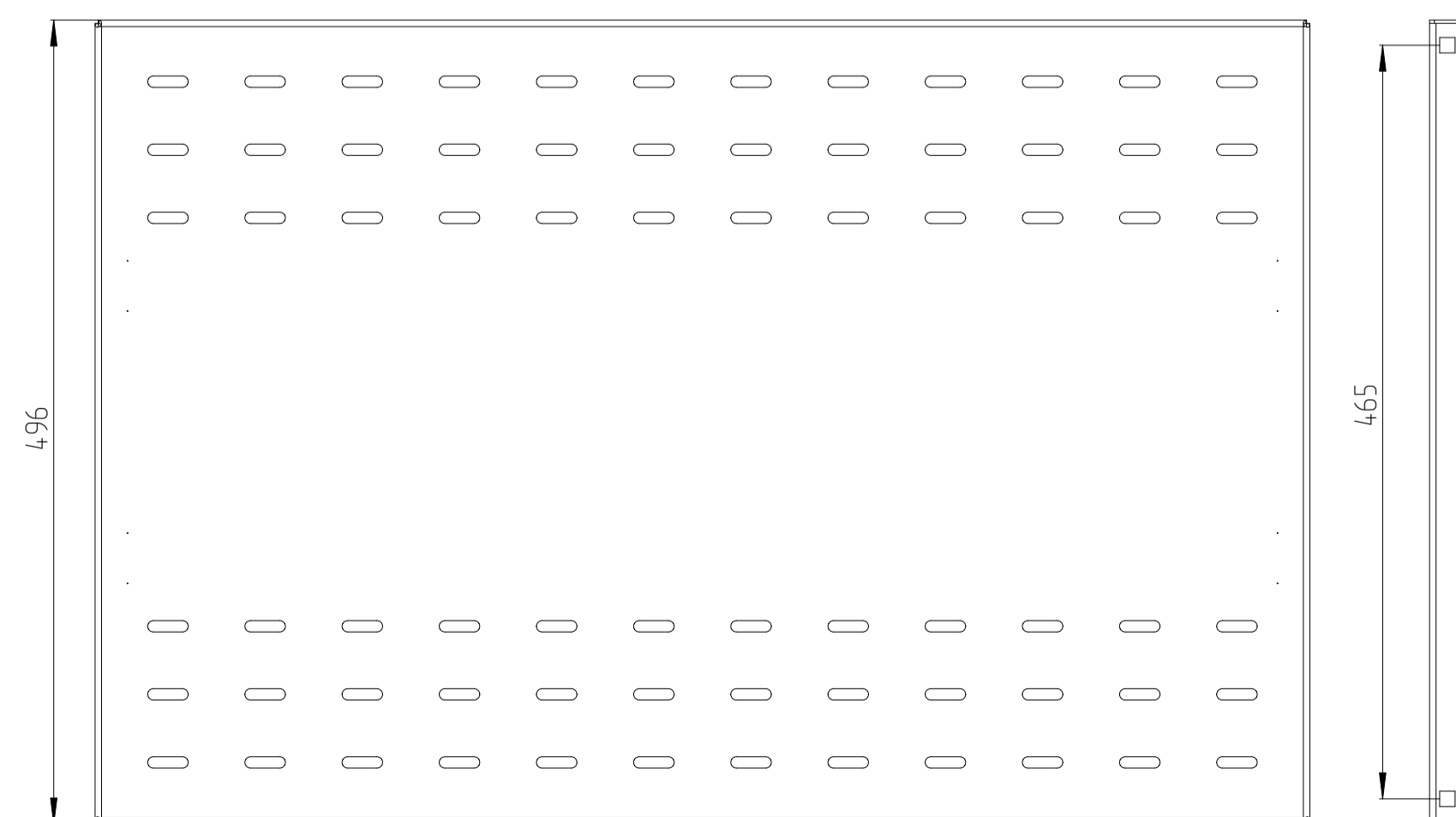
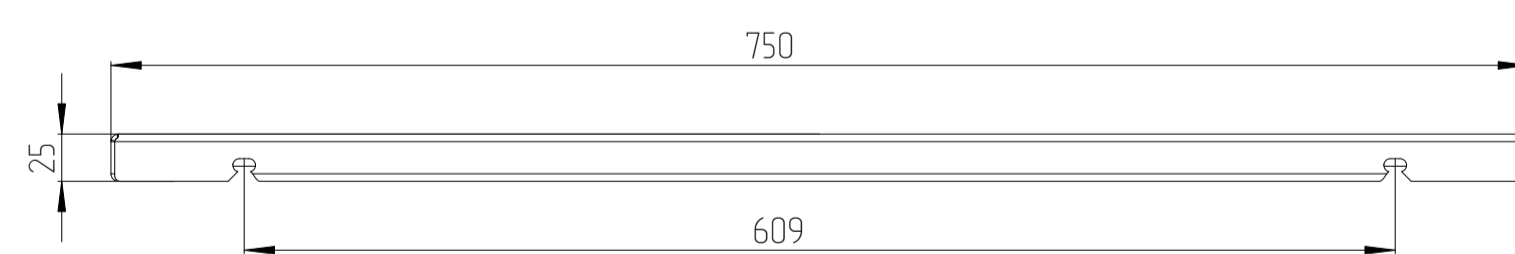

Имя файла модели	ПОЛКА_SV62
Имя файла чертежа	D_INFO_SV_SHKAFI

ИНФО ПОЛКИ СВ

Изм	Лист	N докум	Папн	Дата	Лист
	4				4

Информация о документе: Имя файла модели, Имя файла чертежа, Изм, Лист, N докум, Папн, Дата, Лист

