

Walk-through Metal Detector

User's Manual







Foreword

General

This manual introduces the structure, installation, and configuration of the Walk-through Metal Detector (hereinafter referred to as "the Detector"). Read carefully before using the Detector, and keep the manual safe for future reference.

Safety Instructions

The following signal words might appear in the manual.

Signal Words	Meaning
 DANGER	Indicates a high potential hazard which, if not avoided, will result in death or serious injury.
 WARNING	Indicates a medium or low potential hazard which, if not avoided, could result in slight or moderate injury.
 CAUTION	Indicates a potential risk which, if not avoided, could result in property damage, data loss, reductions in performance, or unpredictable results.
 TIPS	Provides methods to help you solve a problem or save time.
 NOTE	Provides additional information as a supplement to the text.

Revision History

Version	Revision Content	Release Time
V1.0.0	First release.	March 2022

Privacy Protection Notice

As the device user or data controller, you might collect the personal data of others such as their face, fingerprints, and license plate number. You need to be in compliance with your local privacy protection laws and regulations to protect the legitimate rights and interests of other people by implementing measures which include but are not limited: Providing clear and visible identification to inform people of the existence of the surveillance area and provide required contact information.

Interface Declaration

This manual mainly introduces the relevant functions of the device. The interfaces used in its manufacture, the procedures for returning the device to the factory for inspection and for locating its faults are not described in this manual. Please contact technical support if you need information on these interfaces.

About the Manual

- The manual is for reference only. Slight differences might be found between the manual and the product.
- We are not liable for losses incurred due to operating the product in ways that are not in compliance with the manual.
- The manual will be updated according to the latest laws and regulations of related jurisdictions.

For detailed information, see the paper user's manual, use our CD-ROM, scan the QR code or visit our official website. The manual is for reference only. Slight differences might be found between the electronic version and the paper version.

- All designs and software are subject to change without prior written notice. Product updates might result in some differences appearing between the actual product and the manual. Please contact customer service for the latest program and supplementary documentation.
- There might be errors in the print or deviations in the description of the functions, operations and technical data. If there is any doubt or dispute, we reserve the right of final explanation.
- Upgrade the reader software or try other mainstream reader software if the manual (in PDF format) cannot be opened.
- All trademarks, registered trademarks and company names in the manual are properties of their respective owners.
- Please visit our website, contact the supplier or customer service if any problems occur while using the device.
- If there is any uncertainty or controversy, we reserve the right of final explanation.

Important Safeguards and Warnings

This chapter describes the contents covering proper handling of the Detector, hazard prevention, and prevention of property damage. Read these contents carefully before using the Detector, and comply with them when using.

Transportation Requirements



Transport the Detector under the allowed humidity and temperature conditions.

Storage Requirements



- Keep the Detector away from dampness, dust or soot.
- Store the Detector under the allowed humidity and temperature conditions.

Installation Requirements



- Do not place or install the Detector in a place exposed to sunlight or near the heat source.
- Keep the Detector installed horizontally on a stable place to prevent it from falling.
- Install the Detector in a well-ventilated place, and do not block the ventilation of the Detector.

Operation Requirements



- Do not drop or splash liquid onto the Detector, and make sure that there is no object filled with liquid on the Detector to prevent liquid from flowing into the Detector.
- Operate the Detector within the rated range of power input and output.
- Do not disassemble the Detector.
- Use the Detector under the allowed humidity and temperature conditions.

Maintenance Requirements



- Use the battery of specified manufacturer; otherwise there might result in explosion. When replacing battery, make sure that the same type is used. Improper battery use might result in fire, explosion, or inflammation.
- Always replace with the same type of batteries.
- Use the recommended power cables in the region and conform to the rated power specification.
- Use the power adapter provided with the Detector; otherwise, it might result in people injury and device damage.



- The power source shall conform to the requirement of the Safety Extra Low Voltage (SELV) standard, and supply power with rated voltage which conforms to Limited Power Source requirement according to IEC 60068-2. For specific power supply requirements, refer to device labels.

- Connect the Detector (I-type structure) to the power socket with protective earthing.
- The appliance coupler is a disconnection device. When using the coupler, keep the angle for easy operation.

Table of Contents

Foreword	I
Important Safeguards and Warnings.....	III
1 Overview	1
1.1 Introduction	1
1.2 Technical Advantages	1
2 Structure	2
2.1 Dimensions	2
2.2 Host Box	3
2.3 Ports	4
2.4 UPS.....	6
3 Installation.....	8
3.1 Checklist.....	8
3.2 Environmental Requirements.....	8
3.3 Installing Detector	9
3.4 Installing Thermal Camera.....	11
3.5 Multiple Walk-through Site Installation	12
4 Configuration	14
4.1 Login and Changing Password	14
4.1.1 Login	14
4.1.1.1 First-time Login.....	14
4.1.1.2 Not First Time Login	15
4.1.2 Changing Password.....	15
4.2 Operation Access	16
4.3 Desktop.....	16
4.4 Setting Sensitivity	18
4.4.1 Setting Sensitivity Manually	18
4.4.2 Setting Sensitivity Automatically.....	20
4.4.3 Selecting Zones.....	20
4.4.4 Setting Security Level.....	21
4.5 Setting Frequency	22
4.5.1 Setting Frequency Manually	22
4.5.2 Setting Frequency Automatically.....	22
4.5.3 Setting Extended Frequency.....	23
4.6 Setting Program	23
4.6.1 Preset Programs	24

4.6.2 Custom Programs	26
4.7 Setting Alarms.....	27
4.7.1 Alarm Settings.....	27
4.7.2 Random Alarm.....	28
4.7.3 Alarm Tone and Volume.....	29
4.8 Setting IR Mode	29
4.9 Setting Counter	30
4.9.1 Viewing Counter Data	30
4.9.2 Searching for Count Data	31
4.10 System Settings	32
4.10.1 Setting Network.....	32
4.10.2 Setting Desktop	32
4.10.3 Setting Time.....	33
4.10.4 Setting Screen Parameters.....	34
4.10.5 Setting Language.....	35
4.11 Maintenance.....	35
4.11.1 IR Diagnosis.....	35
4.11.2 Factory Reset	35
4.11.3 Self Inspection	36
4.11.4 Viewing Version.....	36
5 Camera Configuration.....	37
5.1 Logging in to Camera Web.....	37
5.2 Enabling Smart Plan	37
5.3 Configuring Temperature Monitoring.....	37
5.4 Configuring Smart Channel.....	39
5.5 Setting Baud Rate.....	40
6 Upgrading Detector	41
6.1 Configuring Network	41
6.2 Viewing Current Version.....	42
6.3 Upgrading Detector	42
7 FAQ	45
Appendix 1 Cybersecurity Recommendations.....	48

1 Overview

1.1 Introduction

With its modular design and strong anti-interference capabilities, the Detector provides optimal performance. It has a user-friendly interface, and is easy to transport and install. Designed with a 7-inch touch screen, it offers remote control and touch screen control, and is also built of specialized and strong materials that make it suitable for various environments.

The Detector detects metal objects using electromagnetic fields, and triggers sound and light alarms when a person is detected to be carrying a metal object. It can cover 18 detection zones, adapts easily to a wide variety of environments, and is built with high-frequency signal generators, a host box, signal receivers, and IR sensors.

The Detector is suitable for security screening of prohibited metal items in railway stations, bus stations, metro rail transit, government buildings, exhibition centers, sports meetings, and schools.

1.2 Technical Advantages

- Multiple applications: Supports 90 programs for different application scenarios, detects magnetic and non-magnetic metals, and filters innocuous metal objects.
- Various alarms: Supports sound and light alarm. Alarm tone, volume, and duration can be adjusted.
- Pass statistics search: Searches for the number of passes by hour or day.
- Network connection: Supports parameter configuration through the network, and supports platform management.
- Cyber security: Supports 2-level users. The operator and the administrator have different access. Ensures cyber security by strict password verification.
- Self-test: Supports manual/automatic self-test.
- Detection capacity: 60–100 persons/min.
- Quick installation and configuration: Supports automatic sensitivity setting and frequency search, and convenient program selection.
- Uninterruptible power supply: Supports sealed lead-acid battery (optional), and automatically detects the battery status for cyclic charging. The charging will stop automatically when the battery is fully charged.
- Traffic lights: Supports traffic lights that inform pedestrians whether the pass is allowed or not.
- Multiple languages: English, Russian, Indonesian, and Turkish are available.
- Two control methods: The 7-inch full color LCD supports touch screen control and remote control.
- Safety: Complies with the EMC Electromagnetic Radiation Standards by using very low frequency electromagnetic fields. No harm caused to pacemakers, pregnant women, or magnetic storage devices.

2 Structure

2.1 Dimensions

Figure 2-1 Dimensions (unit: mm [inch])

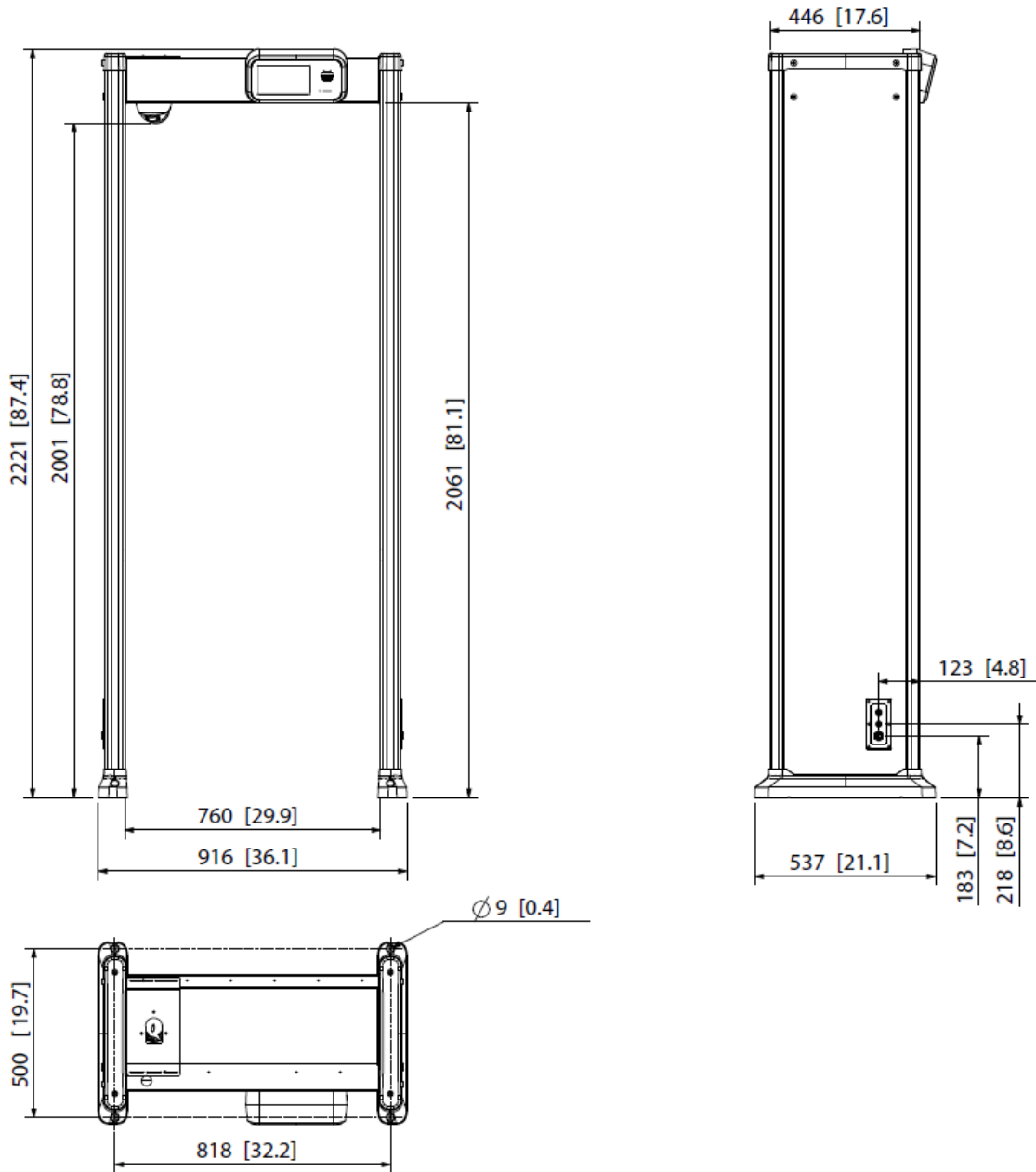

2.2 Host Box

Figure 2-2 Host box



Figure 2-3 Power switch



Table 2-1 Host box description

No.	Name	Description
1	LCD	7-inch full color touch screen LCD.
2	IR Receiver	Receives IR signal.
3	Indicator	<ul style="list-style-type: none"> • Solid green during startup. • Flashes green after startup.
4	Speaker	Outputs audio alarms.
5	Power switch	Press the button to turn on or off the Detector.

2.3 Ports

Figure 2-4 Host ports (1)

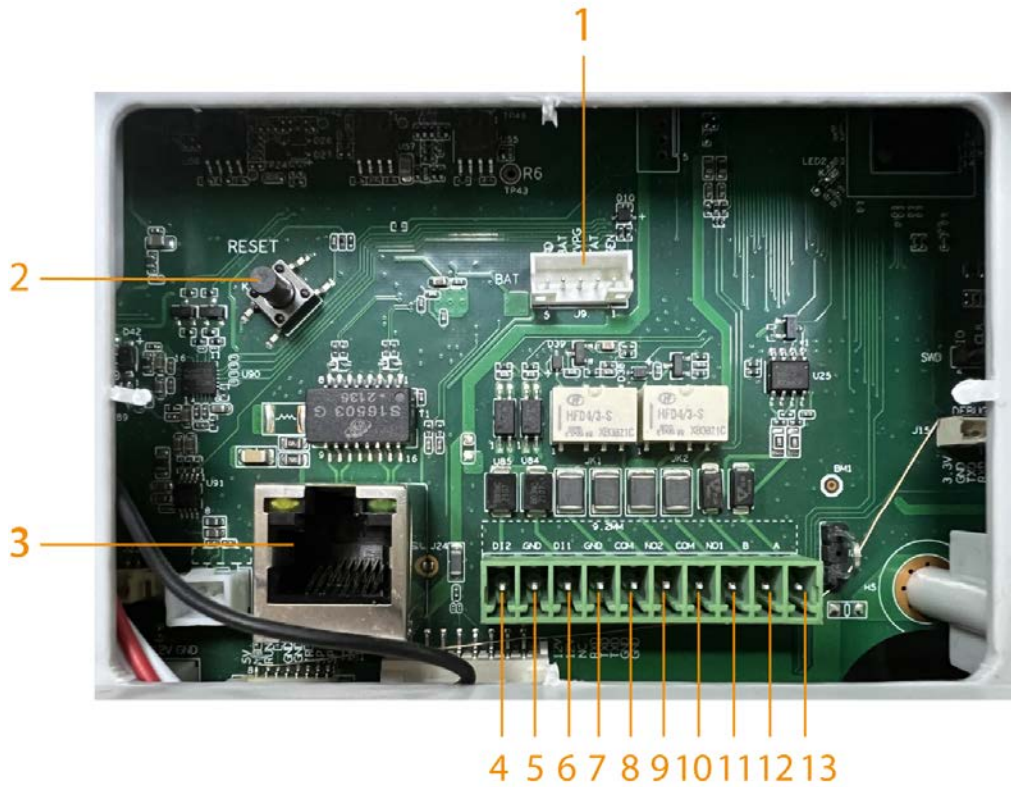





Figure 2-5 Host ports (2)



Figure 2-6 Panel ports



Table 2-2 Port description

No.	Name	Description	
1	Data port	Connects to the data port on the UPS board.	
2	Reset button	Press and hold the button for more than 5 s to restore the Detector to factory default.  Proceed with caution.	
3	Ethernet port	Connects to network with network cable.	
4	Alarm in 2	Receives the signal of external alarm source.	
5			
6			
7	Alarm in 1		
8			
9			
10	Alarm out 2	Outputs alarm signal to alarm device.	
11			
12	Alarm out 1		
12	RS-485 B		Controls external devices. 
13	RS-485 A		<ul style="list-style-type: none"> Connect A and B cables (which both control RS-485) to devices such as thermal cameras. If there are multiple thermal camera decoders, connect A and B cables to 120 Ω resistors.
14	DB25	Signal port for metal detection.	
15	Power in	Inputs 12 VDC power. Be sure to supply power as instructed in the manual.  Detector damage might occur if power is not supplied correctly.	
16	Power out	<ul style="list-style-type: none"> Outputs 12 VDC power. Supports connecting to a thermal camera. 	

No.	Name	Description
17	Power switch	After power on, press this button to start the Detector.
18	Power in	Inputs 12 VDC power.
19	Ethernet port	Connects to a network cable.

2.4 UPS

Uninterruptible Power Supply (UPS) provides emergency power to the Detector when the input power source fails.

Figure 2-7 UPS board port

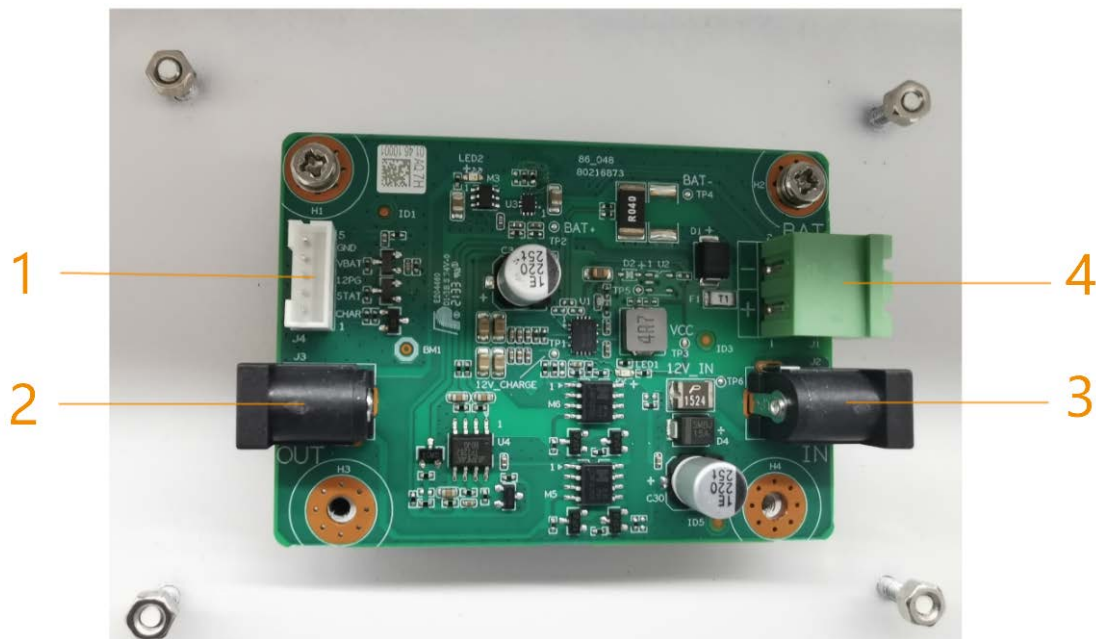



Table 2-3 Port description

No.	Name	Description
1	Data port	Reads the charging status of the sealed lead-acid (SLA) battery.
2	Power out	Outputs 12 VDC power.
3	Power in	Inputs 12 VDC power.  Detector damage might occur if power is not supplied correctly.
4	Storage battery in	Connects to a 12 V SLA battery.

Function of the UPS Board

The SLA battery is connected to the host box through the port 1. When port 3 is connected to 12 V power supply, the UPS board supplies the 12 VDC power to the host box, and at the same time charges the SLA battery through port 4.

When the 12 VDC power of port 3 fails, the UPS board immediately switches the DC power of the SLA battery to discharge mode and supplies power to the host box. The host box accesses whether the battery is connected, charging or discharging through the data port (port 1).

Battery Requirements

Must be a 12 V SLA battery. No capacity limit.

Battery Charging Time

The constant charging current is 500 mA, so the charging time is: $h = C / 500 \text{ mA} \times 1.2$.

Assuming the capacity of a SLA battery is 2 Ah, its charging time will be: $h = 2 \text{ Ah} / 0.5 \text{ A} \times 1.2 = 4.8 \text{ h}$.

SLA Battery Life

- Capacity of the SLA battery: C. Unit: Ah
- Power consumption of the Detector: Min: 15.5 W; Max: 26.5 W
- Voltage of the Detector: 12 V

Assuming the capacity of the SLA battery is 7 Ah, the battery life will be:

- Min: $H = C / A = C / (P / U) = 7 / (26.5 / 12) = 3.17 \text{ h}$
- Max: $H = C / A = C / (P / U) = 7 / (15.5 / 12) = 5.42 \text{ h}$

3 Installation

3.1 Checklist

Table 3-1 Checklist

No.	List	Description	
1	Overall packaging	Appearance	Obvious damage
		Packaging	Accidental impact
		Accessories	Complete or not
2	Host	Appearance	Obvious damage
		Model	Whether consistent with the order contract

Table 3-2 Packing list

Name	Quantity
Door panel	2
Host box	1
Beam	2
Power cord (power input)	1
DB25 cable	2
Fixing screws (M6 × 16)	4
Fixing screws (M8 × 80)	8
Remote control	1
Wrench	1
Dry cell	2
Key	1
Network cable	1
Accessory cable	1
AC/DC power adapter	1
Thermal camera	1
Thermal camera fixing bracket	1
Thermal camera fixing screws	5

3.2 Environmental Requirements

- The ground is flat and sturdy
The ground should be flat and firmly supporting to prevent vibration. If there is a vibrating metal structure under the ground, there can be unnecessary alarm when people pass through the metal detector. Do not install the Detector on a metal ground.
- Keep away from fixed metal objects

Large metal objects that are fixed or immobile should be at least 50 cm away from the Detector (detecting large metal objects) because they might make the Detector more susceptible to vibration.



The distance in this section is the recommended distance. The actual installation distance depends on the installation site conditions.

- Keep away from moving metal objects
Large moving metal objects should be kept 0.5 m to 2 m away from the Detector to avoid false alarms. Depending on the size of the metal object, the distance between the moving metal object and the Detector might vary.
- Keep away from radioactive electronic interference
The distance between the electronic interference source and the receiving coil should be as large as possible. The recommended minimum distance is 0.5 m to 4 m. However, the actual distance needs to be based on specific circumstances. For example, you can go through a metal detector with a source of interference until the best position is found. Interference can occur from electronic control panels, radios and computers, image displays, high-power motors and transformers, AC wires, transistor control circuits, flash fluorescent tubes, arc welding equipment, and more.
- Keep away from conductive electronic interference
Connect the power cable to a line that is not connected to other large loads, such as high-power motors, because they can cause a large power or voltage shock in the line.

3.3 Installing Detector

Step 1 Open the packing box and take out the accessories.

Step 2 Open the rear beam with the key, and then attach the host box to the rear beam with eight M6 × 16 screws. Close the rear beam.

Figure 3-1 Attach host box

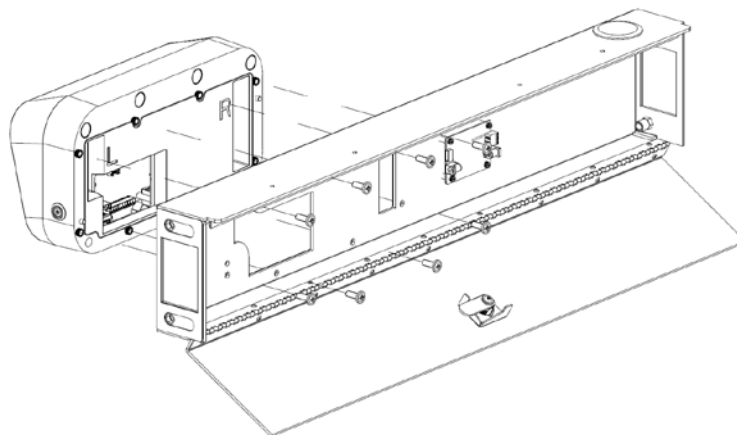

Step 3 Attach the two beams to the two door panels with eight M8 × 8 screws.

Figure 3-2 Attach beams and panels

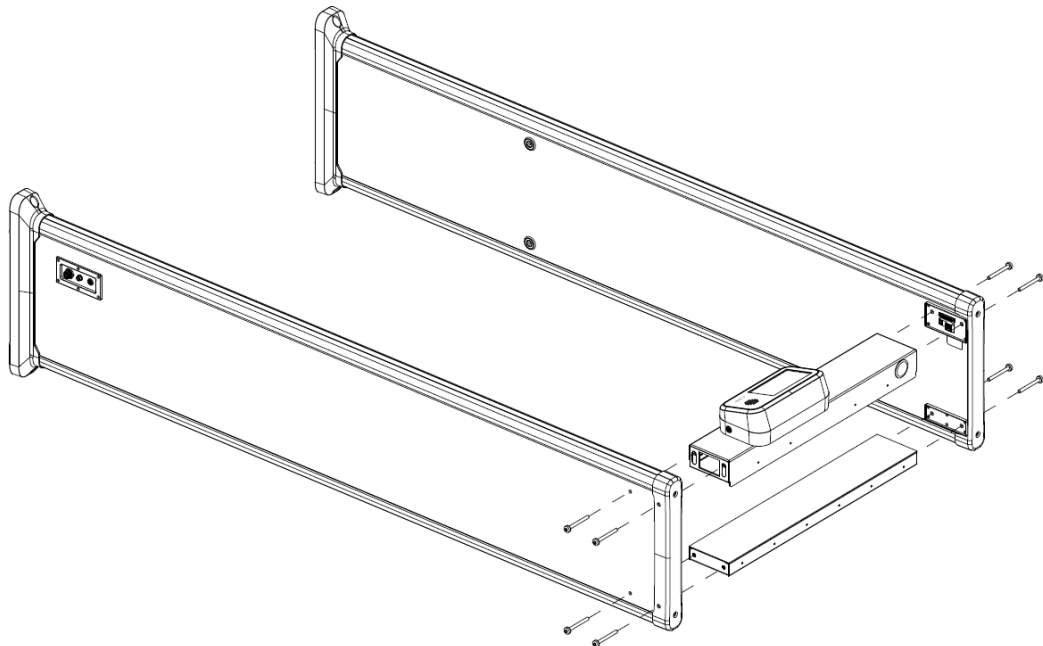

Step 4 Stand the Detector up, and open the back cover.

Step 5 Connect the cables.

- 1) Connect one end of the two DB25 cables to the host box and the other to the door panel.
- 2) Connect one end of the data cable to the data port on the motherboard and the other to the data port on the battery charging board.
- 3) Connect one end of the network cable to the motherboard and the other to either side of the door panel.
- 4) Connect one end of the first power cable to the IN port of the motherboard and its other end to the OUT port of the battery charging board. Afterwards, connect one end of the second power cable to the IN port of the battery charging board, and its other end to the power port of either door panel.

Figure 3-3 Connect cables

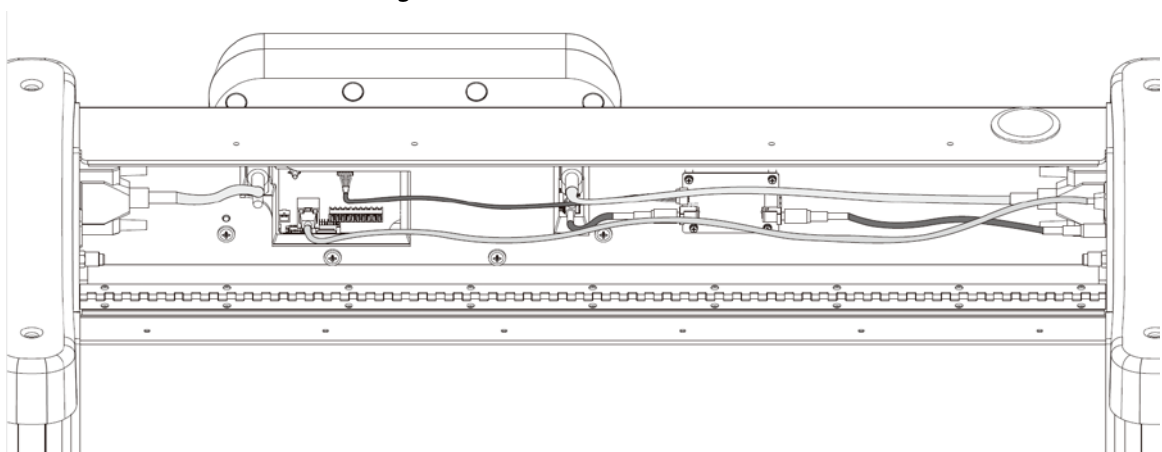

Step 6 Close the back cover of the rear beam.

Step 7 Connect the power supply to the door panel, and then turn on the power switch to start the Detector. Connect a network cable as needed.

3.4 Installing Thermal Camera

- Step 1** Use the Allen wrench to loosen the screws to disassemble the camera into three parts.
- Step 2** Attach the camera base to the fixing bracket with three M4 × 16 screws. Place the camera and its cover back in the original position.

Figure 3-4 Assemble camera

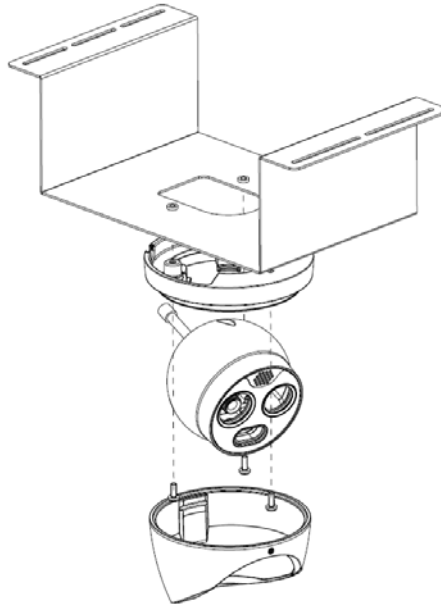

- Step 3** Open the back cover of the Detector, take out the power cord and RS-485 cable from the accessories, and then connect them to the ports of the Detector. Run the power cord and the RS-485 cable through the opening of the back cover.
- Step 4** (Optional) If you need to connect the camera to an external network such as a LAN, connect a network cable (not provided) to the door panel, and then run it through the opening of the back cover.

Figure 3-5 Connect camera cables

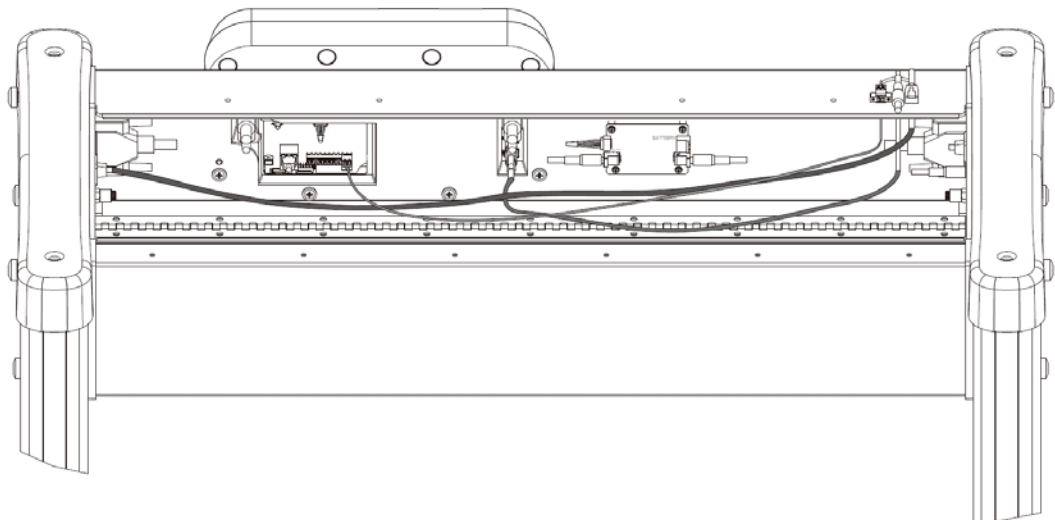

- Step 5** Close the back cover and place the bracket together with the camera between the two beams. Move the camera to a suitable position and secure it with two to three M4 × 16 screws.

Figure 3-6 Place and fix the camera

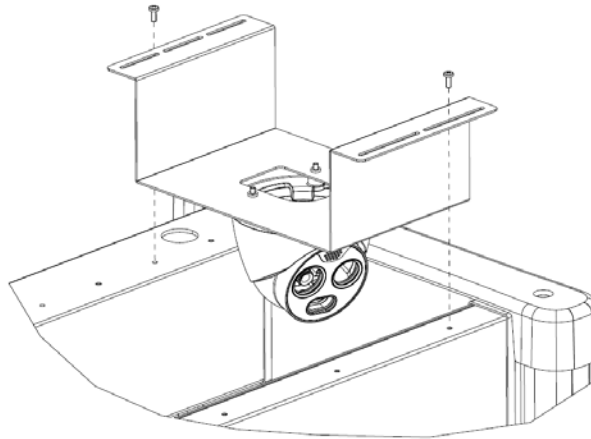

Step 6 Connect the power cord, RS-485 cable, and the network cable to the corresponding ports of the Detector and the camera.

Figure 3-7 Connect camera cables

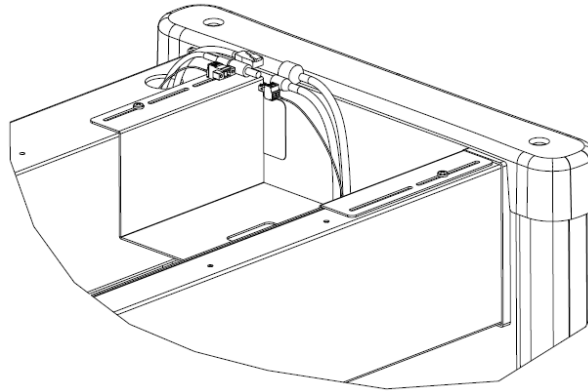

Step 7 Adjust the camera to a suitable angle.

3.5 Multiple Walk-through Site Installation

When installing multiple devices, space the devices at least 50 cm, and also space the device and X-ray security screening machine larger than 50 cm. This recommended spacing can make the little metal objects (such as coin) detected. If you install the devices with space smaller than 50 cm, there might be false alarm. If the spacing needs to be shorten because of limited installation site, you need to adjust the frequency, lower the security level and sensitivity according to the actual situation; otherwise, small metal objects might not be detected.

Figure 3-8 Multiple walk-through detectors site installation

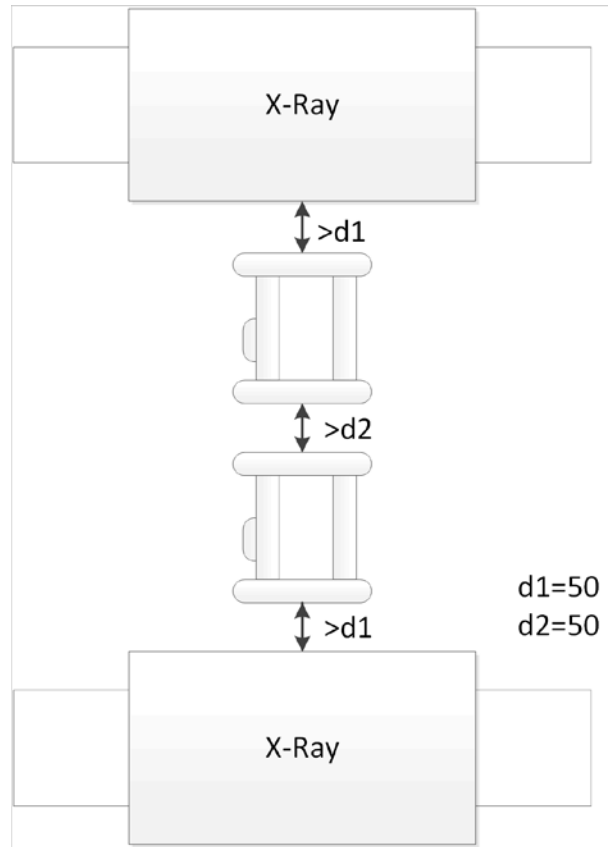

4 Configuration



The LCD display might be different depending on the model that you purchased.

4.1 Login and Changing Password

4.1.1 Login

You can set the parameters as needed. To prevent unauthorized modifications, password protection is in place.

Every time you go to the menu from the desktop, you need to enter the password.

4.1.1.1 First-time Login

Step 1 Power on the Detector, press the power button, and then wait for about 5 s. The system displays **Booting Up**.

Step 2 Select a language. English, Russian, Indonesian, and Turkish are available.

Step 3 Tap **Next** to set the date and time.

Step 4 Tap **Finish** to enter the desktop.

Figure 4-1 Desktop

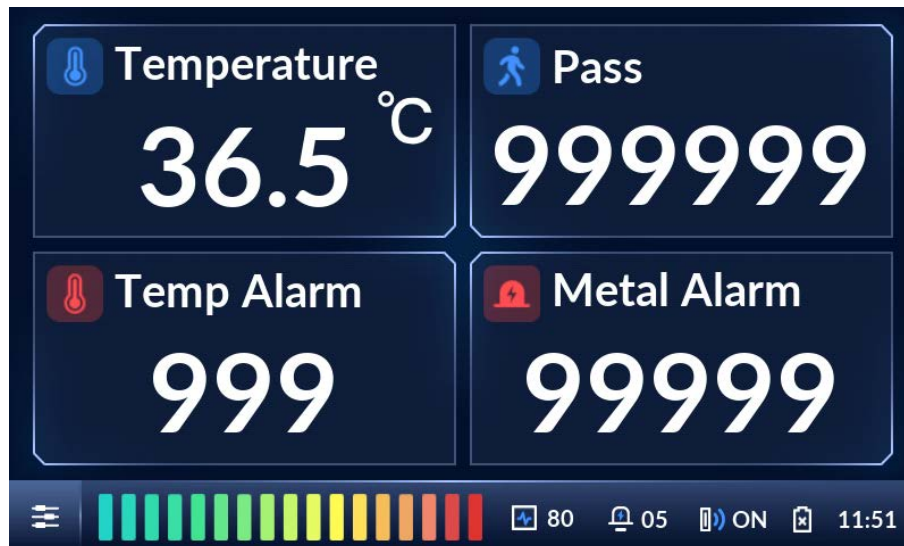

Step 5 Tap  on the lower-left of the desktop to go to the login screen.

Step 6 Select **Admin** or **Operator**, and then enter the corresponding password.

- The password for **Admin** is admin123 by default.
- The password for **Operator** is operator123 by default.



We recommend that you change the password.

Figure 4-2 Login

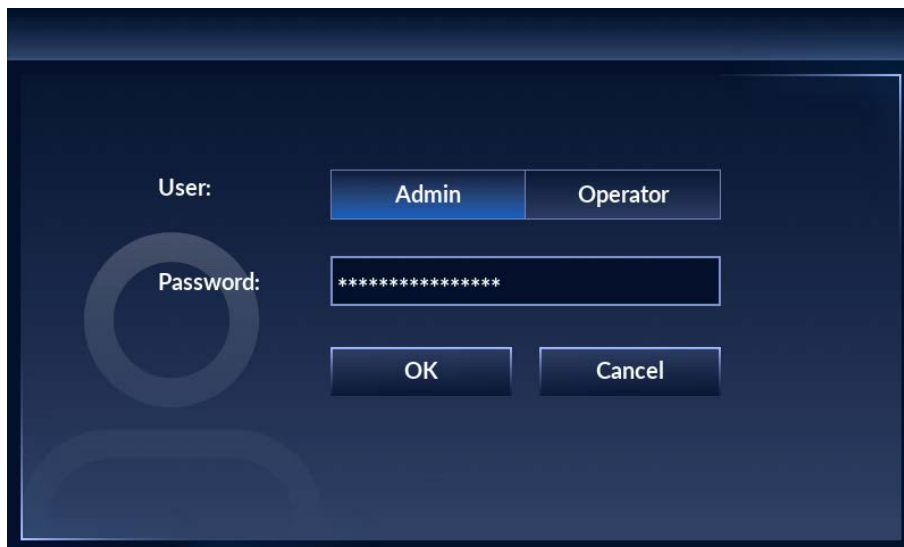

Step 7 Tap **OK** to go to the menu.

Figure 4-3 Menu



4.1.1.2 Not First Time Login

The desktop is displayed after the Detector is started.

Step 1 Power on the Detector, press the power button, and then wait for about 5 s. The system displays **Booting Up**.

The desktop is displayed.

Step 2 Tap  on the lower-left of the desktop to go to the login screen.

Step 3 Select **Admin** or **Operator**, and then enter the corresponding password.

Step 4 Tap **OK** to go to the menu.

4.1.2 Changing Password

Change your password regularly to ensure system security.

Step 1 Tap  on the lower-left of the desktop, and then enter the password to go to the menu.

Step 2 Select **System** > **Password**.

Step 3 Enter your old password, new password, and then confirm your new password.



The password must consist of 8 to 16 digits of both letters and numbers.

Figure 4-4 Change password



Step 4 Tap **OK**.

Step 5 The system prompts **Successfully modified the password**.

4.2 Operation Access

To ensure security and avoid data tampering, the admin account and the operator account are designed with different operation access.

- The admin account has full access to all settings.
- The operator account only has access to changing operator password, setting custom program, adjusting the volume, clearing counter data, and searching for counter record.

4.3 Desktop

There are two modes of desktop: metal alarm desktop and temperature alarm desktop.

Tap  on the lower-left of the desktop, and then enter the password to go to the menu. Tap **System** > **Desktop Setting** to switch desktop. For details, see "4.10.2 Setting Desktop".

Figure 4-5 Metal alarm desktop

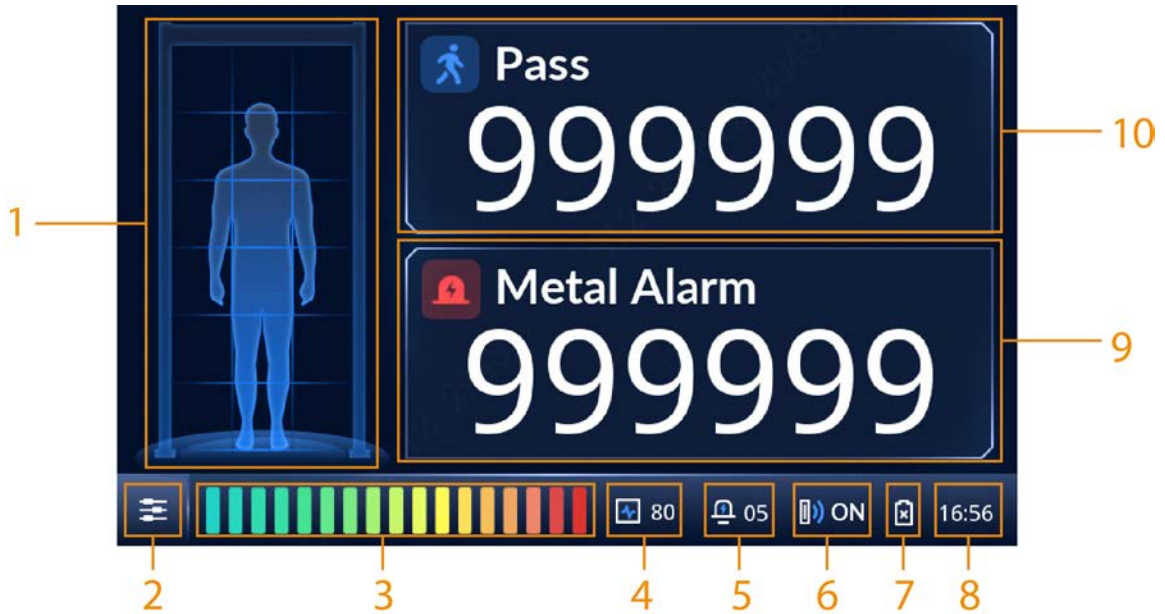

Figure 4-6 Temperature alarm desktop

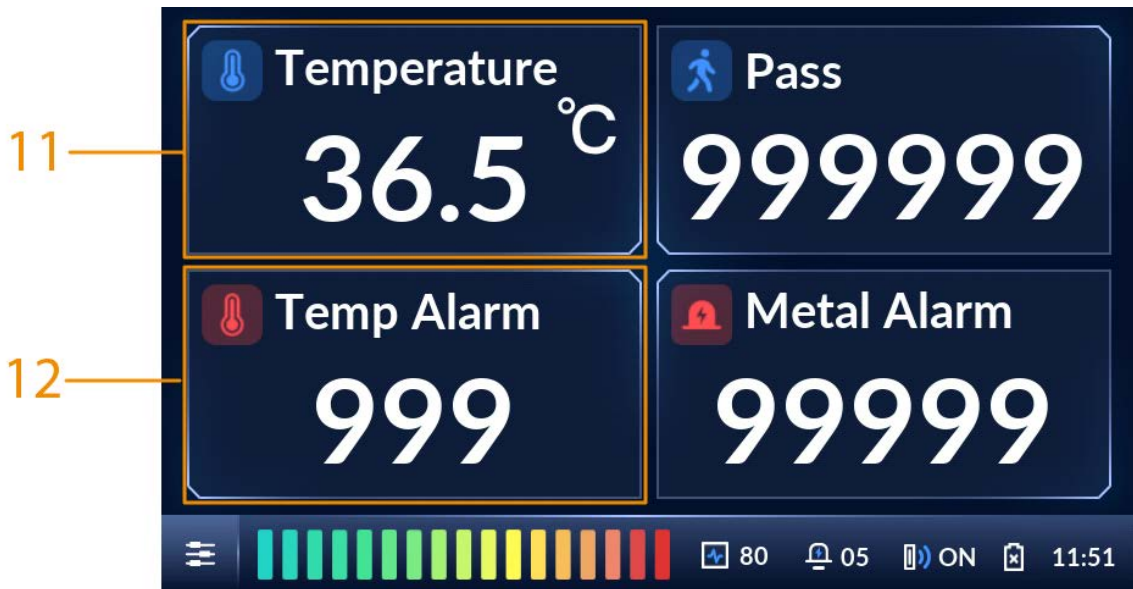







Table 4-1 Desktop parameters

No.	Description
1	Location of metal objects. The detector panel can be set to 6, 12, or 18 zones.
2	Tap  , and then enter the password to go to the menu to configure parameters.
3	Intensity of metal detection.
4	Frequency.
5	Alarm volume.
6	IR status. For details, see "4.7.1 Alarm Settings".

No.	Description
7	<p>The status of the SLA battery.</p> <ul style="list-style-type: none"> : Charging. : Fully charged. : Discharging. : No battery.
8	Current time.
9	Total number of metal alarms.
10	Number of people walking through the Detector.
11	Body temperature of the person walking through.
12	Number of temperature alarms.

4.4 Setting Sensitivity

Sensitivity relates to metal detection capability.

You can manually set the sensitivity of zones or automatically set the sensitivity by carrying metals and walking through the Detector. You can change the number of zones, and set the security level. When both the defined threshold of security level and sensitivity are reached, an alarm will be triggered.

4.4.1 Setting Sensitivity Manually

Prerequisites

You have selected a zone mode.



18-zone mode is the factory default. To switch to 6-zone or 12-zone modes, select **Sensitivity > Zone Management**. For details, see "4.4.3 Selecting Zones".

You can adjust the sensitivity of individual zones, or set a same sensitivity for all zones.

Procedure

Step 1 Tap  on the lower-left of the desktop to go to the login screen.

Step 2 Select **Sensitivity > Sensitivity**.

Figure 4-7 Set 6-zone sensitivity

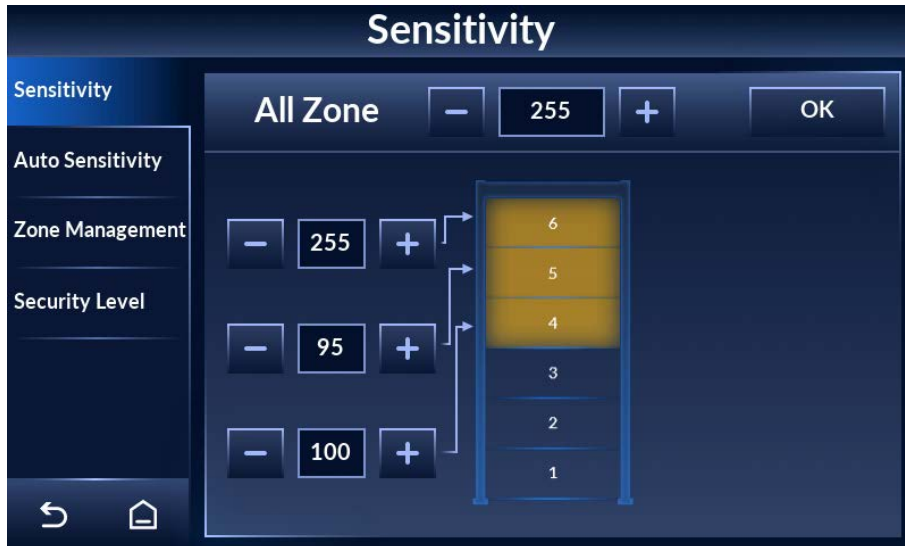

Figure 4-8 Set 12-zone sensitivity

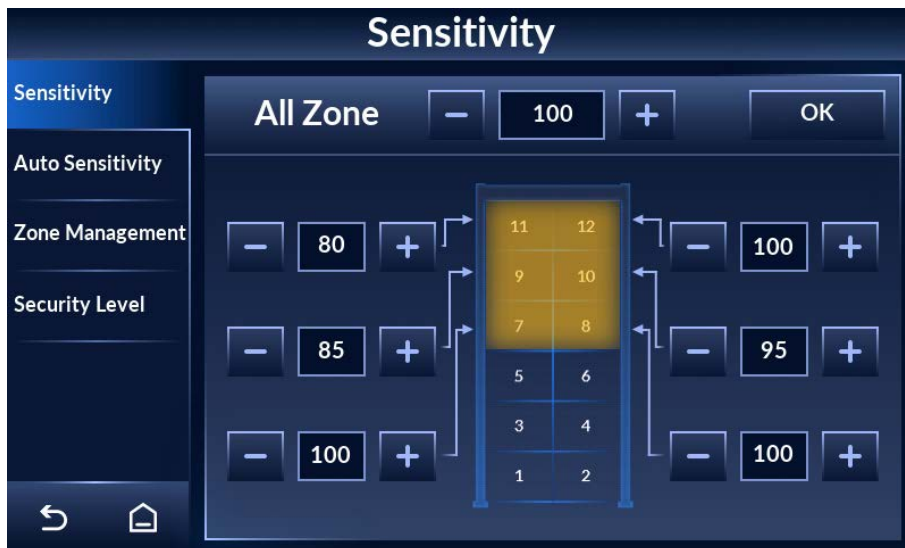
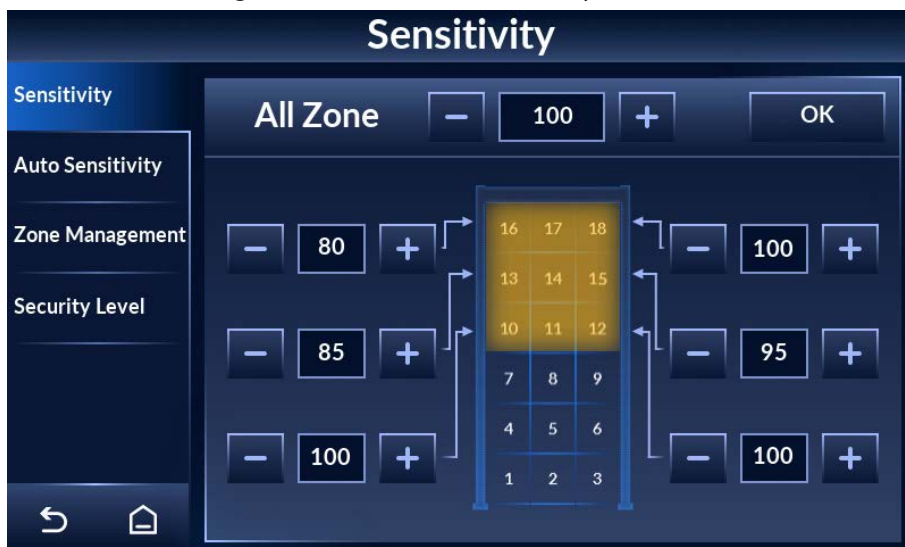

Figure 4-9 Set 18-zone sensitivity



Step 3 Tap **+** or **-** to set the sensitivity of each zone.
You can set a same sensitivity for all zones, or set the sensitivity of individual zones. The sensitivity range is 0–255. At higher sensitivity settings, smaller metal objects are detected.

Conversely, at lower sensitivity settings, only larger metal objects are detected. Keep in mind that the sensitivity should be set high enough so that the smallest forbidden objects are detected.

- Set a same sensitivity for all zones: Adjust the sensitivity behind **All Zone**, and then tap **OK**.
- Set the sensitivity of individual zones: Adjust the sensitivity of individual zones where the arrows point to, and the change takes effect immediately.

4.4.2 Setting Sensitivity Automatically

You can automatically set the sensitivity of all zones by walking through the Detector with metal objects.

Step 1 Tap  on the lower-left of the desktop to go to the login screen.

Step 2 Select **Sensitivity** > **Auto Sensitivity**.

Figure 4-10 Set automatic sensitivity

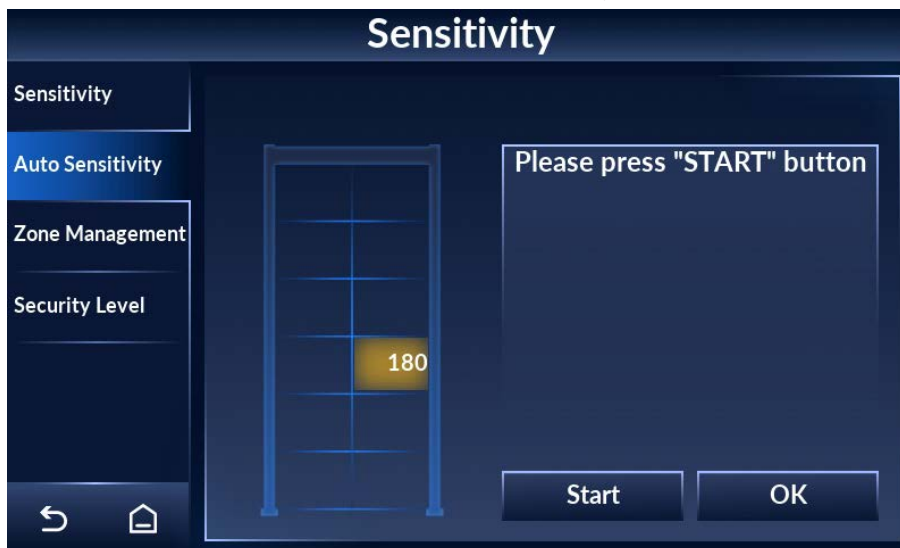

Step 3 Tap **Start**, and then walk through the Detector with metal objects for at least three times, so that three sensitivity values are recorded.

Step 4 Tap **OK**.

The maximum sensitivity automatically becomes the sensitivity of all zones. You can view the sensitivity by tapping the **Sensitivity** tab.

4.4.3 Selecting Zones

The door can be divided to 6, 12, and 18 zones to locate the position of metal. With more zones, the metal can be located more accurately.

Step 1 Tap  on the lower-left of the desktop to go to the login screen.

Step 2 Select **Sensitivity** > **Zone Management**.

Step 3 Select the number of zones according to your detection needs.

Figure 4-11 Zone management



4.4.4 Setting Security Level

Security level is the detection sensitivity of the Detector as a whole.



Sensitivity only works for each individual zone. For a metal object to trigger alarm, both the sensitivity and the security level need to reach the alarm threshold.

Step 1 Tap  on the lower-left of the desktop to go to the login screen.

Step 2 Select **Sensitivity** > **Security Level**.

Step 3 Tap  or  to adjust the security level.

It ranges from 1 to 100. The higher the value is, the more secure and sensitive the whole Detector is.

When both the defined threshold of security level and sensitivity are reached, an alarm will be triggered.

Figure 4-12 Set security level

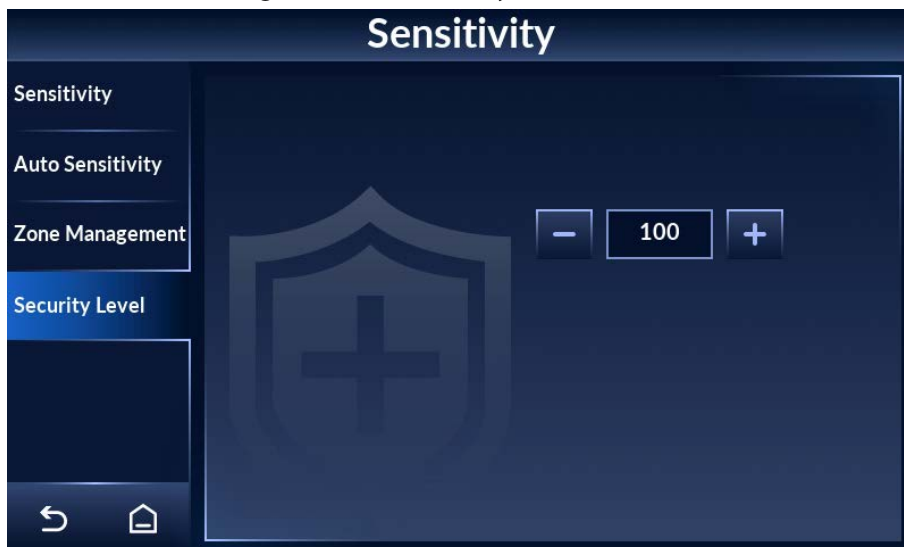



4.5 Setting Frequency

For multiple walk-through metal detector operation, set each of them to a different frequency to reduce mutual interference.

4.5.1 Setting Frequency Manually

Step 1 Tap  on the lower-left of the desktop to go to the login screen.

Step 2 Select **Frequency** > **Manually**.

Step 3 Tap  or  to adjust frequency.

The frequency range is 1 to 20 by default, and can be extended to 100. For details, see "4.5.3 Setting Extended Frequency".

Figure 4-13 Set frequency manually

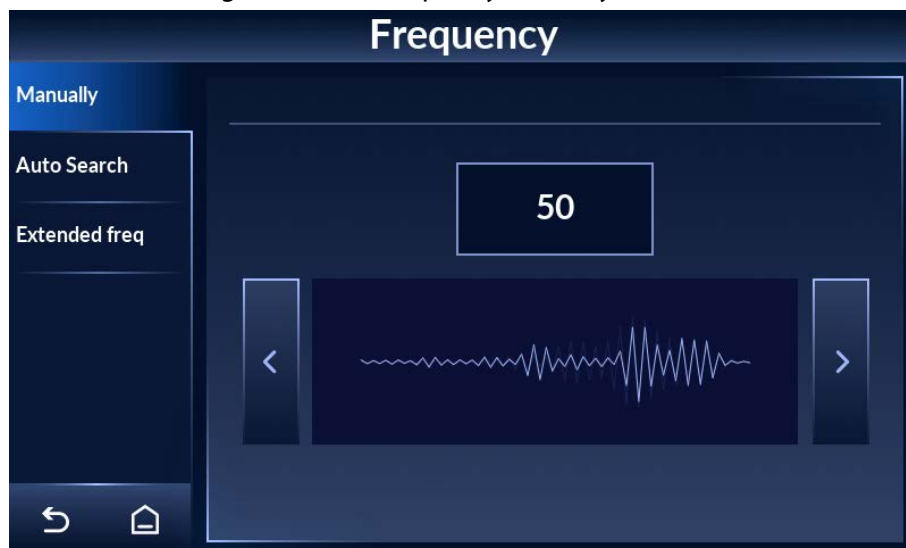

4.5.2 Setting Frequency Automatically

Based on the environment, the Detector automatically searches for a suitable frequency to reduce interference by other working walk-throughs in close proximity.

Step 1 Tap  on the lower-left of the desktop to go to the login screen.

Step 2 Select **Frequency** > **Auto Search**.

Step 3 Tap **Start**, and then a pop-up displays on the screen.

Step 4 Tap **OK**, and then the Detector starts to search for a frequency automatically. The process takes about 40 s, during which no operation will be responsive.

Figure 4-14 Automatic search



4.5.3 Setting Extended Frequency

For multiple walk-through metal detector operation, you can extend the frequency range to reduce interference.

Step 1 Tap  on the lower-left of the desktop to go to the login screen.

Step 2 Select **Frequency** > **Extended freq.**

Step 3 Tap  to enable extended frequency, and tap  to disable it.

The extended frequency ranges from 1 to 100. It is disabled by default.

Figure 4-15 Set extended frequency

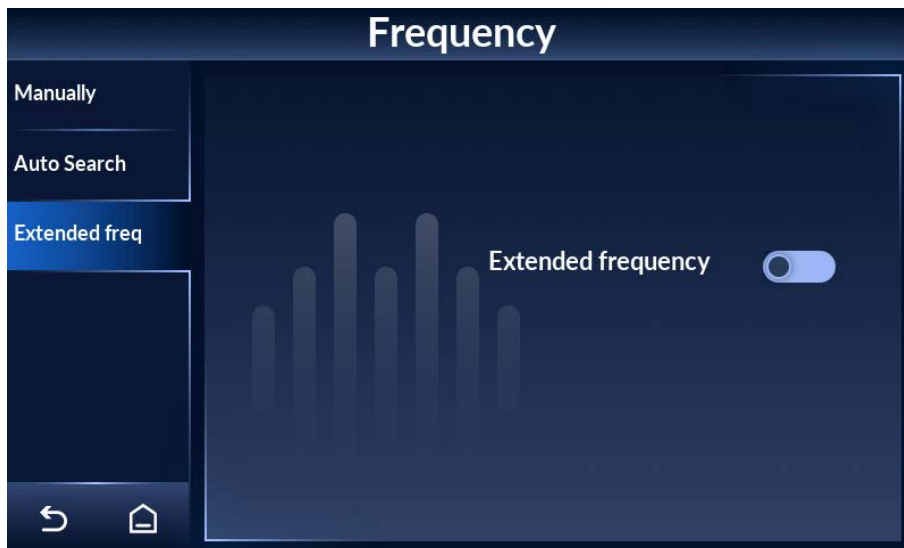

4.6 Setting Program



Each program has its own set of sensitivity, and is therefore different in metal detection capability. After setting program, the default sensitivity will change correspondingly. A total of 90 programs are available, including 80 preset and 10 custom ones.

4.6.1 Preset Programs

Each preset program is designed with a set of sensitivity suitable for a certain scenario.

Step 1 Tap  on the lower-left of the desktop to go to the login screen.

Step 2 Select **Program > Preset**.

Step 3 Select a program that suit your application scenario. Tap  or  to go to the previous or next page.

Eighty preset programs are available. Each program is designed with a set of parameters. You can adjust the parameters as needed.



The system will save your adjustment disregard of restart.

Figure 4-16 Preset program (1)



Figure 4-17 Preset program (2)



Figure 4-18 Preset program (3)



Figure 4-19 Preset program (4)



Table 4-2 Preset program description

Name	Description
High, All Metals HS, Critical infrastructures, Borders, Procuratorates, Court House, Prisons, and Mail	Highest detection level. Detects all dangerous objects.
Middle, All Metals, and Buildings	Medium detection level. Detects forbidden objects such as small guns.
Low, and All Metals LS	Low detection level. Detects strictly forbidden objects such as guns, and filters glasses, watches, coins, and other small metal objects.
High throughput, and Strong anti-interference	Suitable for use in complex environments with strong anti-interference capability and low sensitivity. Detects strictly forbidden objects such as guns, and filters glasses, watches, coins, and other small metal objects.
NILECJ L1	For L1 of NILECJ 0601.00.
NILECJ L1A	For L1 Augment of NILECJ 0601.00.
NILECJ L2	For L2 of NILECJ 0601.00.

Name	Description
NILECJ L2A	For L2 Augment of NILECJ 0601.00.
NILECJ L3	For L3 of NILECJ 0601.00.
NILECJ L3A	For L3 Augment of NILECJ 0601.00.
NILECJ L4	For L4 of NILECJ 0601.00.
NILECJ L5	For L5 of NILECJ 0601.00.
NIJ LO	For Large object of NIJ0601.02.
NIJ MO	For Medium object of NIJ0601.02.
GB3	For level III of GB15210:2018.
GB2	For level II of GB15210:2018.
GB1	For level I of GB15210:2018.
Schools, Restaurants, Hotels, Hospitals, Bar, Special Events, Exhibitions, Concert Halls, Arenas, Railway Stations, Bus Stations, Metro Stations, and Stadiums	Suitable for use in places with large people flow. Detects forbidden objects such as small guns, and filters glasses, watches, coins, and other small metal objects.
Logistics, Express, and Warehouse	Detects small guns and knives, and filters glasses, watches, coins, and other small metal objects.
Airport3	Detects small guns and knives, and filters glasses, watches, coins, and other small metal objects.
Airport2, EU Std2	Detects small guns and knives, and filters glasses, watches, coins, and other small metal objects.
Airport1, EU Std1	Detects small guns and knives, and filters glasses, watches, coins, and other small metal objects.
Magnetic HS	Filters non-magnetic metals. Highest detection level. Detects all dangerous objects.
Magnetic	Filters non-magnetic metals. Medium detection level. Detects forbidden objects such as small guns.
Magnetic LS	Filters non-magnetic metals and small metal objects such as glasses, watches, and coins. Low detection level. Detects strictly forbidden objects such as guns.
Non-Magnetic HS	Filters magnetic metal. Highest detection level. Detects all dangerous objects.
Non-Magnetic	Filters magnetic metals. Medium detection level. Detects dangerous non-magnetic metal objects and small guns.
Non-Magnetic LS	Filters magnetic metals and small metal objects such as glasses, watches, and coins. Low detection level. Detects strictly forbidden objects such as guns.

4.6.2 Custom Programs

For custom programs, sensitivity of all zones is 255 by default.

Step 1 Tap  on the lower-left of the desktop to go to the login screen.

Step 2 Select **Program > Custom**.

Step 3 Select a custom program.

Ten custom programs are available. You can customize the parameters.

Figure 4-20 Custom programs



4.7 Setting Alarms

4.7.1 Alarm Settings

- Step 1 Tap  on the lower-left of the desktop to go to the login screen.
- Step 2 Select **Alarm** > **Alarm Setting**.
- Step 3 Configure alarm settings.

Figure 4-21 Alarm settings

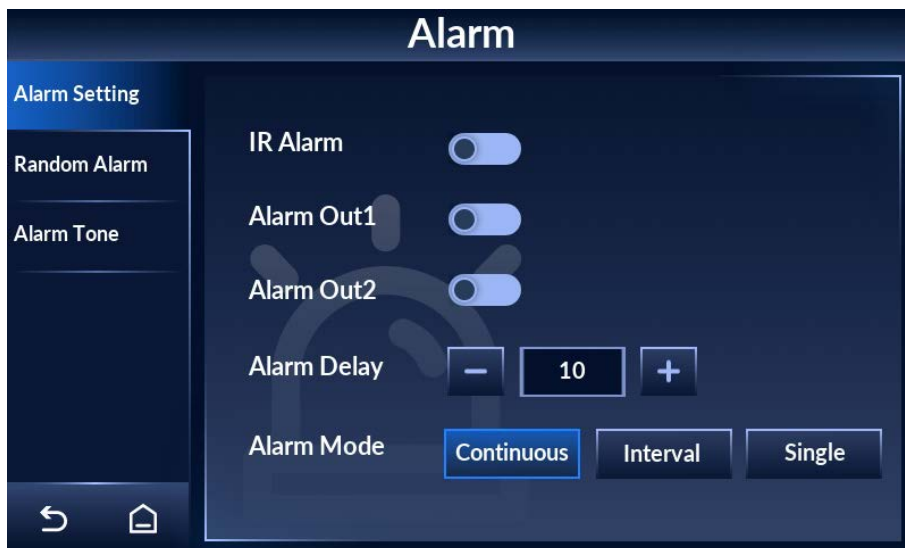











Table 4-3 Alarm setting parameter description

Item	Descriptions
IR Alarm	<p>Tap  to enable IR alarm, and tap  to disable it. IR status is displayed by  on the bottom of the desktop.</p> <p> After enabling IR alarm, an alarm will be triggered only when a person passing through the Detector with forbidden metal objects are detected by the IR sensors.</p>
Alarm Out1	There are two ports on the motherboard that can connect to alarm devices such as light and audio alarms.
Alarm Out2	<ul style="list-style-type: none"> • : Normally open, with the alarm off (default). • : Normally closed, with the alarm on.
Alarm Delay	Tap  or  to adjust the duration of sound and light alarm. The value ranges from 0 to 10 seconds. Zero means no alarm.
Alarm Mode	<ul style="list-style-type: none"> • Continuous (default): Each zone triggers alarm one after another. • Interval: Alarm zones cannot be adjacent. For example, for zone 1 to zone 6, if zone 3 triggers an alarm, zone 2 and zone 4 will not trigger alarms, but zone 1, zone 5, or zone 6 can trigger alarms. • Single: Only the zone with the strongest metal detection will trigger alarms. <p> The interval mode and the single mode can reduce interference between adjacent zones.</p>

4.7.2 Random Alarm

Random alarm is to validate whether the Detector is working.

Step 1 Tap  on the lower-left of the desktop to go to the login screen.

Step 2 Select **Alarm > Random Alarm**.

Step 3 Tap  to enable random alarm and tap  to disable it.

Step 4 Set random alarm rate, which ranges from 1% to 100%.

This feature provides the ability to randomly trigger alarm on a selected percentage of non-alarmed persons.

Figure 4-22 Random alarm



4.7.3 Alarm Tone and Volume





- Step 1 Tap  on the lower-left of the desktop to go to the login screen.
- Step 2 Select **Alarm > Alarm Tone**.
- Step 3 Select an alarm tone, and then adjust the volume.
- Nine tones are available. Tone 1 is selected by default. The system plays the tone after it is selected.
 - Tap  to turn up the volume and tap  to turn down the volume.

Figure 4-23 Alarm tone and volume



4.8 Setting IR Mode

- Step 1 Tap  on the lower-left of the desktop to go to the login screen.
- Step 2 Select **IR > IR Mode**.
- Step 3 Select an IR alarm mode.
Four modes are available.

- Start both groups: The counter adds one pass when both groups of IR sensors are triggered. In this mode, the IR alarm will be automatically turned on.
- Close both groups: The IR alarm will be automatically turned off.
- Start rear IR group: The counter adds one pass when the rear IR group is triggered.
- Start front IR group: The counter adds one pass when the front IR group is triggered.

Figure 4-24 Set IR mode



4.9 Setting Counter

The counter records the number of people who pass through the Detector.

4.9.1 Viewing Counter Data

Procedure

Step 1 Tap  on the lower-left of the desktop to go to the login screen.

Step 2 Select **Counter** > **Counter**.

Step 3 View the number of people who pass through the Detector.

From left to right, the numbers stand for the number of entries (from front to rear), the number of exits (from rear to front), the number of alarms on entry, the number of alarms on exit, and the number of temperature alarms.



The side with the LCD is the rear side.

Figure 4-25 Counter



Related Operations

- Tap  to enable the automatic reset function of the counter. After it is enabled, the numbers will be cleared automatically when the limit (999999) is reached.
- Tap **Clear** to manually clear all data.

4.9.2 Searching for Count Data



- Step 1 Tap  on the lower-left of the desktop to go to the login screen.
- Step 2 Select **Counter** > **Search**.
- Step 3 Set the start time and end time. You can search for data from up to 30 days.
- Tap  to switch the search unit (hour/day).

Figure 4-26 Search



- Step 4 Tap **Search**, and the data will be displayed.

4.10 System Settings

You can set the IP address, password, desktop, date and time, and more.
To change the password, see "4.1.2 Changing Password".

4.10.1 Setting Network

- Step 1 Tap  on the lower-left of the desktop to go to the login screen.
- Step 2 Select **System** > **Network**.
- Step 3 Enter the IP address (192.168.1.108 by default), subnet mask, and gateway.

Figure 4-27 Set network



- Step 4 Tap **OK**.

4.10.2 Setting Desktop

You can set the display mode of the desktop, and the counting method of the Detector.

- Step 1 Tap  on the lower-left of the desktop to go to the login screen.
- Step 2 Select **System** > **Desktop Setting**.
- Step 3 Tap **Metal Alarm Desktop** or **Temp Alarm Desktop** to switch desktop.
For desktop description, see "4.3 Desktop".

Figure 4-28 Metal alarm desktop



Tap  to switch between Celsius degrees and Fahrenheit.

Figure 4-29 Temperature alarm desktop

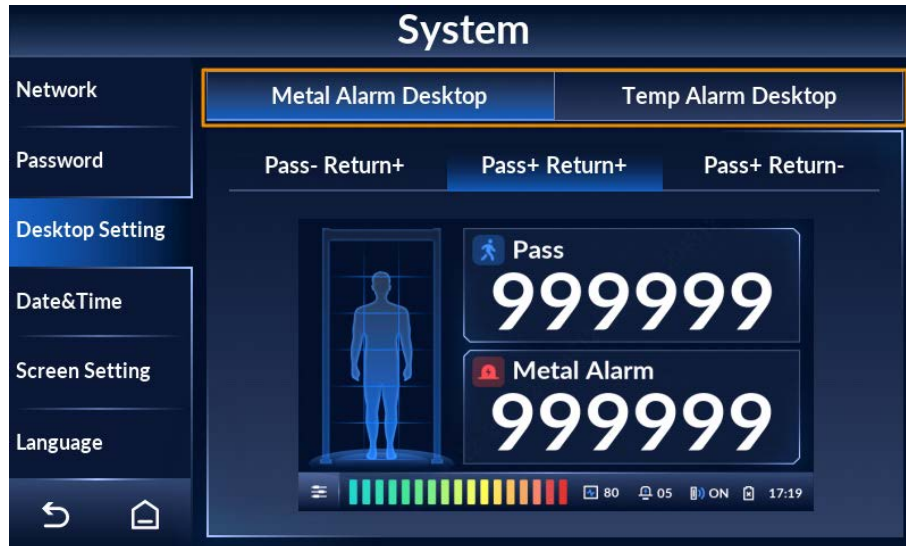
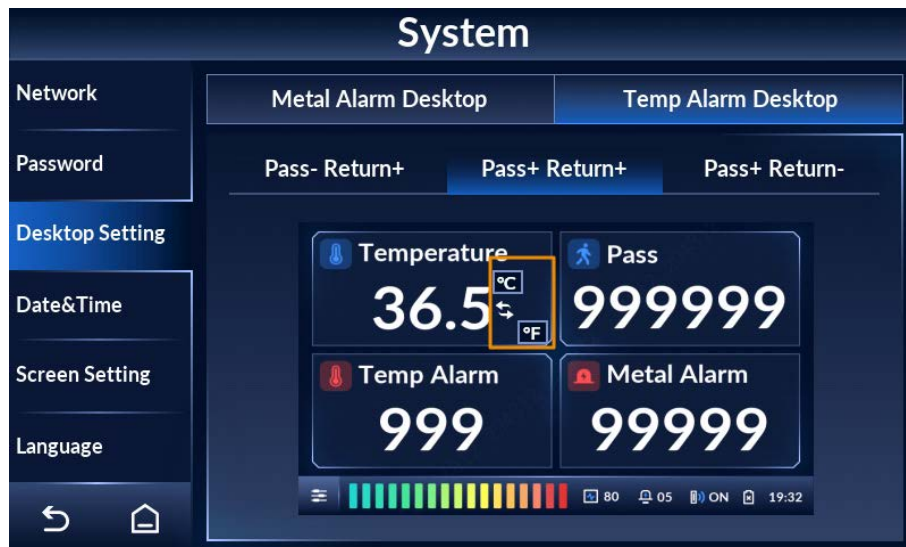

Step 4 Select a counting method from Pass- Return+, Pass+ Return+, and Pass+ Return-.





The side with the LCD is the rear side.

- Pass- Return+: Counts people passing in the reverse direction only and subtracts from the count for people passing in the forward direction.
- Pass+ Return+: Counts people passing in both directions.
- Pass+ Return-: Counts people passing in the normal forward direction only and subtracts from the count for people passing in the reverse direction.

4.10.3 Setting Time

Step 1 Tap  on the lower-left of the desktop to go to the login screen.

Step 2 Select **System** > **Date&Time**.

Step 3 Tap  or  to adjust the date and time.

Step 4 Tap **OK**.

Figure 4-30 Set date and time.



4.10.4 Setting Screen Parameters

Step 1 Tap  on the lower-left of the desktop to go to the login screen.

Step 2 Tap **System > Screen Setting**.

Step 3 Set the parameters.











- Sleep: Tap  to enable the sleep mode and tap  to disable it. Tap  or  to adjust the sleep time. In the sleep mode, if there is no operation for longer than the sleep time, the brightness of the screen will be reduced. If the brightness is less than a half of the maximum, it will remain the same.
- Logout: Tap  or  to adjust the automatic logout time. If there is no operation for longer than the logout time, the system will go back to the desktop.
- Tap  or  to adjust screen brightness.

Figure 4-31 Set screen parameters

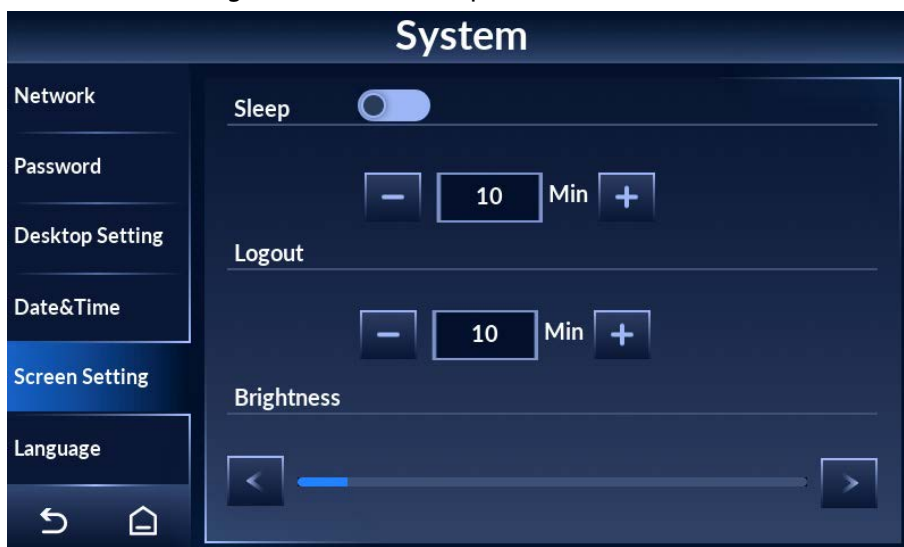

4.10.5 Setting Language

Step 1 Tap  on the lower-left of the desktop to go to the login screen.

Step 2 Select **System > Language**.

English, Russian, Indonesian, and Turkish are available.

4.11 Maintenance

You can perform IR diagnosis, reset factory settings, start system self-inspection, and view the version.

4.11.1 IR Diagnosis

Step 1 Tap  on the lower-left of the desktop to go to the login screen.

Step 2 Select **Maintain > IR Diagnosis**.

Step 3 Set front/rear IR group initial status, and view front/rear IR group real-time status.



- Tap , and the IR will be on when the Detector is powered on. Tap , and the IR will be off when the Detector is powered on.
- Real-time status: 1 means there is no block between the IR sensors. 0 means there is block between the IR sensors.

Figure 4-32 IR diagnosis



4.11.2 Factory Reset

Step 1 Tap  on the lower-left of the desktop to go to the login screen.

Step 2 Select **Maintain > Factory Reset**.

Step 3 Tap **Factory Reset**, and the system prompts **Restore factory and reboot?**

Step 4 Tap **OK**, and the Detector restarts.

4.11.3 Self Inspection

Step 1 Tap  on the lower-left of the desktop to go to the login screen.

Step 2 Select **Maintain** > **Self Inspection**.

Step 3 Tap **Start**, and the system checks the items one by one.



During self inspection, all the other operations on the Detector are invalid.

Figure 4-33 Self inspection

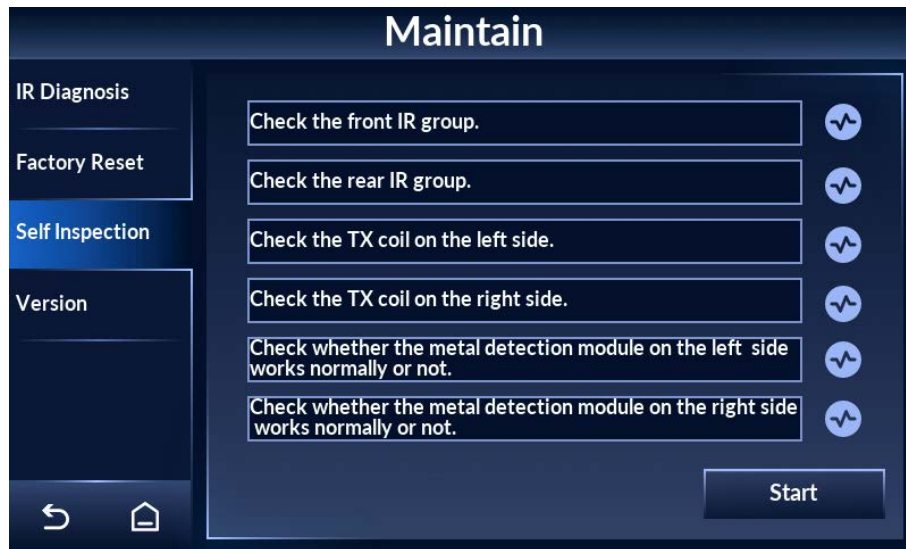

4.11.4 Viewing Version

You can view the system version, the screen version, and their build dates.

Step 1 Tap  on the lower-left of the desktop to go to the login screen.

Step 2 Select **Maintain** > **Version** to view system version and screen version.



The version might be different depending on the model you purchased.

Figure 4-34 View version details



5 Camera Configuration

With a thermal camera, the Detector supports temperature monitoring. The detection rules are configured by default, and you can change the configuration as needed. For details, see *Thermal Hybrid Camera_Web Operation Manual*.

5.1 Logging in to Camera Web

- Step 1 Open IE browser (IE7 and later), enter the IP address of the device (192.168.1.108 by default) in the address bar and press the Enter key.
- Step 2 Enter the username (admin by default) and password.
- Step 3 Click **Login**.

5.2 Enabling Smart Plan

- Step 1 Log in to the web page of the camera.
- Step 2 Select **Setting > Event > Smart Plan**.
- Step 3 Enable thermal temperature monitoring.
Click  to enable it, and the icon is highlighted.

Figure 5-1 Smart Plan



5.3 Configuring Temperature Monitoring

Thermal temperature monitoring is enabled. For details, see "5.2 Enabling Smart Plan".

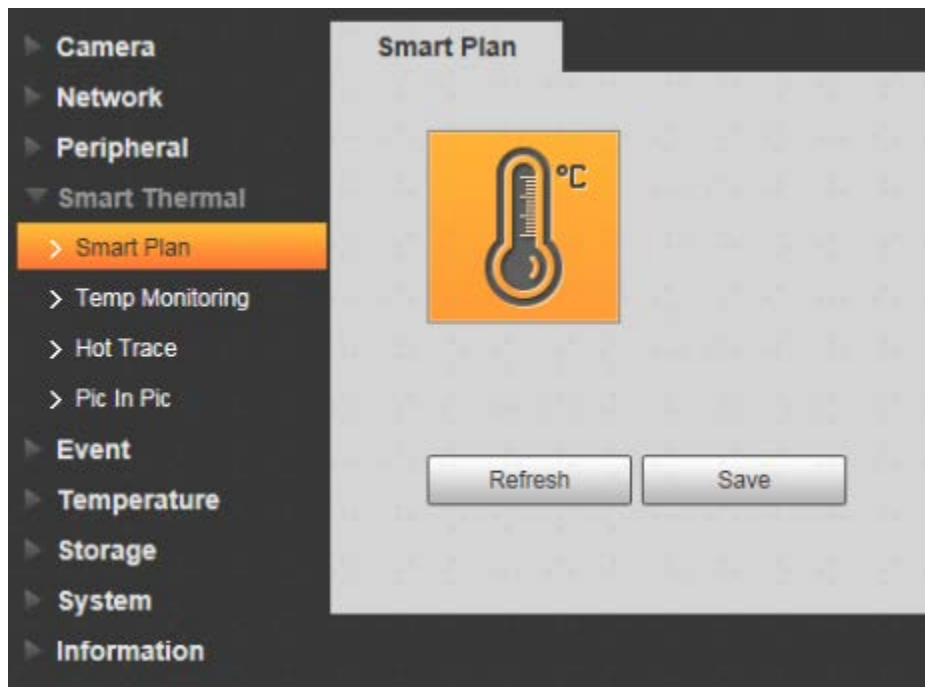
- Step 1 Log in to the web page of the camera.

Step 2 Select **Setting > Smart Thermal > Temp Monitoring**.

Step 3 Click **Draw Rule** to draw a detection area.

Confirm that the lower border of the detection area is near people shoulders and upper border can be the upper edge of the thermal image.

Step 4 Select the **Enable** check box. It is selected by default.

Configure thermal temperature monitoring parameters.

Figure 5-2 Temperature monitoring

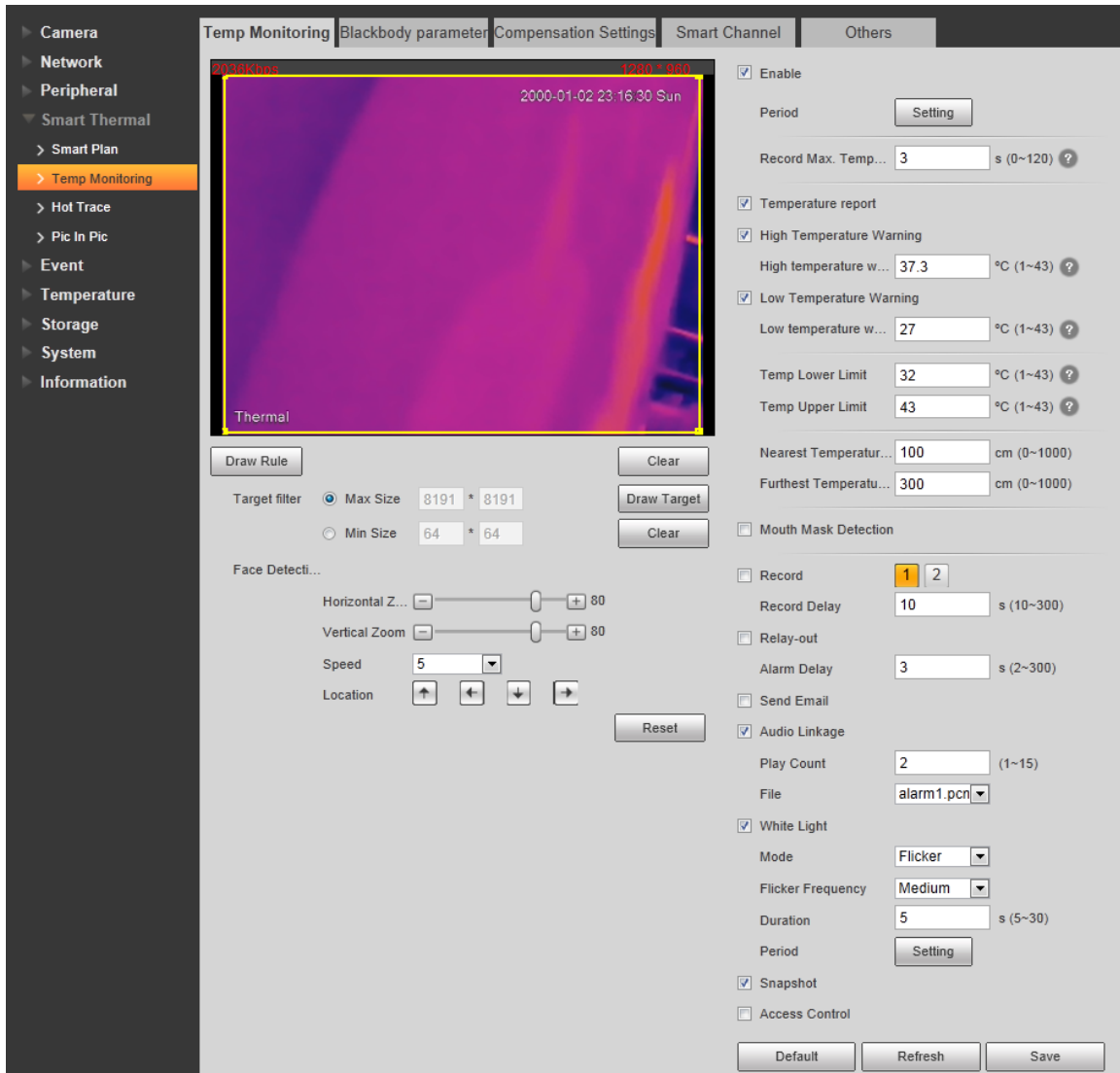

Step 5 Configure thermal temperature monitoring parameters.

Table 5-1 Description of temperature monitoring parameter

Parameter	Description
Period	<p>Define a period during which the alarm settings are valid.</p> <ol style="list-style-type: none"> 1. Click Setting, and the period setting page is displayed. 2. Configure period. <ul style="list-style-type: none"> • Method 1: Press and drag the left mouse button on the time line. • Method 2: Click Setting corresponds to a day in a week, and then configure periods as needed (6 periods are available). 3. Click Save.

Parameter	Description
Record Max. Temperature	Set the period during which the camera will monitor the temperature, and capture the image when the temperature reaches the highest value. It is 3 s by default. When the value is 0, it means that the camera will capture the image when the target appears in the detection area.
Temperature Report	Enable temperature report, and the temperature is displayed on the screen of the Detector in real time.
High Temperature Warning	Enable the high temperature warning, and then set the warning threshold. It ranges from 1 °C to 43 °C (37.3 °C by default). When the monitored temperature is higher than or equal to this value, an alarm is triggered.
Low Temperature Warning	Enable the low temperature warning, and then set the warning threshold. It ranges from 1 °C to 43 °C (27 °C by default). When the monitored temperature is lower than or equal to this value, an alarm is triggered.
Temp Lower Limit	Set the lower limit of the body temperature. The camera only monitors temperature that is higher than or equal to this value. It is 43 °C by default.
Temp Upper Limit	Set the upper limit of the body temperature. The camera only monitors temperature that is lower than or equal to this value. It is 32 °C by default.
Nearest Temperature Distance	The camera detects the target between the nearest temperature distance and furthest temperature distance. It takes effect after the distance detection is enabled. The nearest temperature distance is 50 cm, and the furthest temperature is 200 cm by default.
Furthest Temperature Distance	 Select Setting > Smart Thermal > Smart Channel to enable distance detection.

5.4 Configuring Smart Channel

Step 1 Log in to the web page of the camera.

Step 2 Select **Setting > Smart Thermal > Smart Channel**.

Figure 5-3 Temperature monitoring

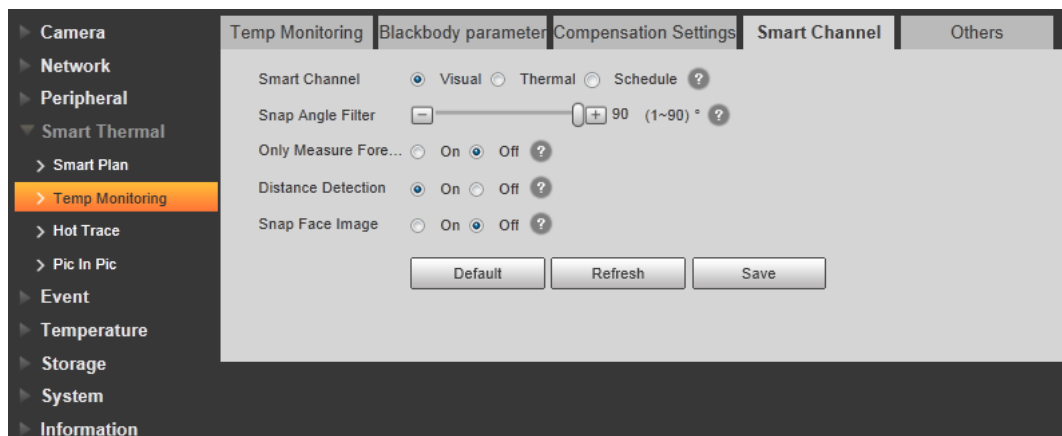

Step 3 Select the display mode of the channel.

- Visual: It is selected by default.
- Thermal: When the light is not good (such as black light, and the light is not enough), we recommend you select **Thermal**.
- Schedule: Select **Schedule** and then configure the schedule. The two channels will switch automatically as the configured schedule.

- Step 4** (Optional) Configure **Snap Angle Filter**.
- 1: The camera detects frontal faces only.
 - 90 (default): The camera detects side faces only.



Snap angle filter is only supported when you select **Visual** from the display mode of smart channel.

- Step 5** Enable **Only Measure Forehead** as needed.
After enabling this function, the camera only detects the temperature of the forehead area. It can reduce the false alarm caused by the high temperature of background.
- Step 6** Enable **Distance Detection** as needed.
It is enabled by default.
- Step 7** Enable **Snap Face Image** as needed.
- Step 8** Click **OK**.

5.5 Setting Baud Rate

- Step 1** Log in to the web page of the camera.
- Step 2** Select **Setting > System > PTZ Setting**.
- Step 3** Set the baud rate. It is 115200 by default.
You need to set it to 115200, so that temperature data can be transmitted to the Detector.
Keep other parameters as default.
- Step 4** Click **OK**.

Figure 5-4 Set baud rate

The screenshot shows the PTZ Settings configuration page. On the left is a navigation menu with categories: Camera, Network, Peripheral, Smart Thermal, Event, Temperature, Storage, System (with sub-items: General, Account, Safety, PTZ Settings, Default, Import/Export, Auto Maintain, Upgrade), and Information. The PTZ Settings sub-item is highlighted in orange. The main content area is titled 'PTZ Settings' and contains the following fields:

- Protocol: DH-SD1 (dropdown)
- Address: 1 (text input)
- Baud Rate: 115200 (dropdown)
- Data Bit: 8 (dropdown)
- Stop Bit: 1 (dropdown)
- Parity: NONE (dropdown)

At the bottom of the settings area are three buttons: Default, Refresh, and Save.

6 Upgrading Detector

You can use ConfigTool to upgrade the Detector software.



Go to

<https://www.dahuasecurity.com/support/downloadCenter/tools/MaintenanceTools?child=332> to download ToolBox, and then install ConfigTool.

6.1 Configuring Network

Before upgrading the Detector, you need to connect your computer and the Detector to the same local network first.

- Step 1** Connect a network cable to the network port of the door panel, so that the Detector and your computer are in the same LAN.
- Step 2** Set the IP of the Detector and the computer on the same network segment. For example, if the IP of the Detector is 192.168.1.108 by default, you can set the IP of the computer as 192.168.1.111.
- Step 3** Open ConfigTool, and then select **Modify IP > Search Setting**.
- Step 4** Enter the network segment of the Detector in the **Start IP** box and **End IP** box.
- Step 5** Enter the username and password of the Detector. The password is the same as the login password of the admin account.

Figure 6-1 Search for the Detector on ConfigTool

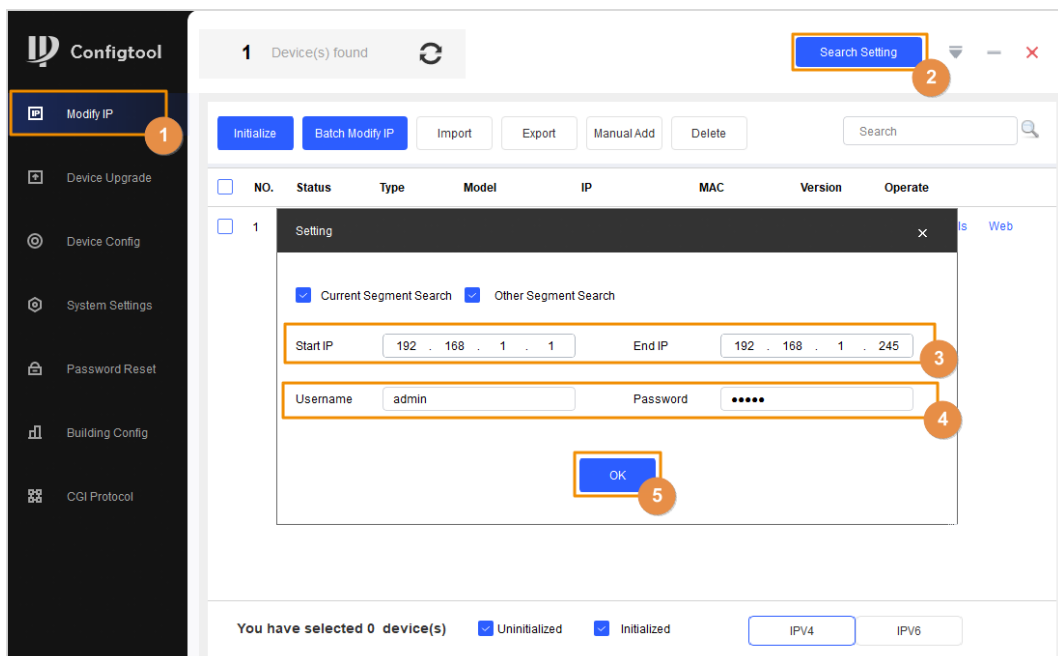

- Step 6** Click **OK**.

6.2 Viewing Current Version

Click **Details** to view the current software version of the Detector.

Figure 6-2 View current version

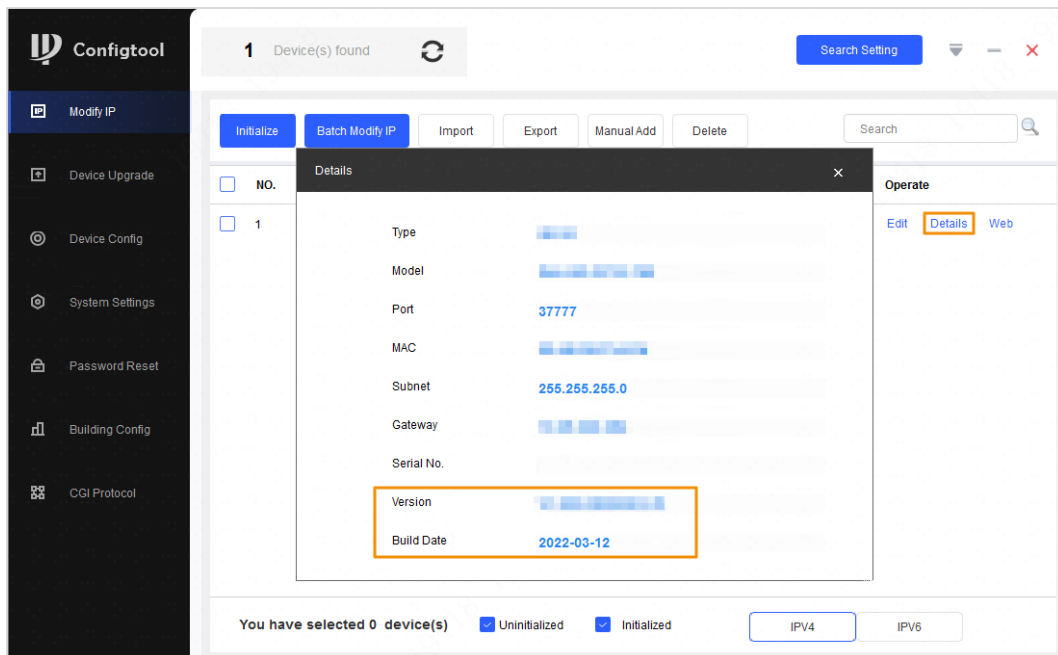

6.3 Upgrading Detector

Select the bin file to upgrade the Detector.

1. Click **Device Upgrade**.
2. Upgrade the program.
 - Upgrade the screen program.
Click , select the ota.bin file from the General_ISC-D7xx_Eng_SCREEN_V1.000.000000.0R_xxxxxx directory, and then click **Open**.

Figure 6-3 Select upgrade file



- Upgrade the main control module program.
Click , select the General_ISC-D7xx_Eng_App_MCU_V1.000.0000000.0.R.xxxxxx.bin file from the General_ISCD-D7xx_Eng_MCU_V1.000.0000000.0.R_xxxxxx directory, and then click **Open**.

Figure 6-4 Select upgrade file

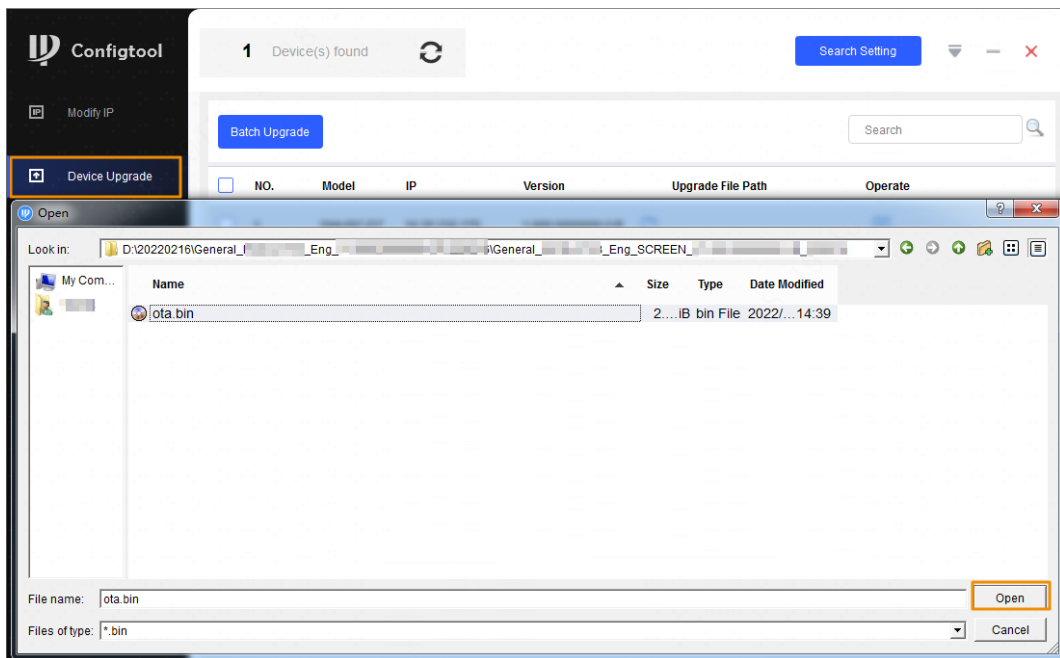

3. Click  to start upgrading.
After upgrade is complete, a notice dialog box will be displayed indicating the Detector will be restarted. Then the Detector restarts automatically.
4. A green tick is displayed after the upgrade is successful.

Figure 6-5 Upgrade completed

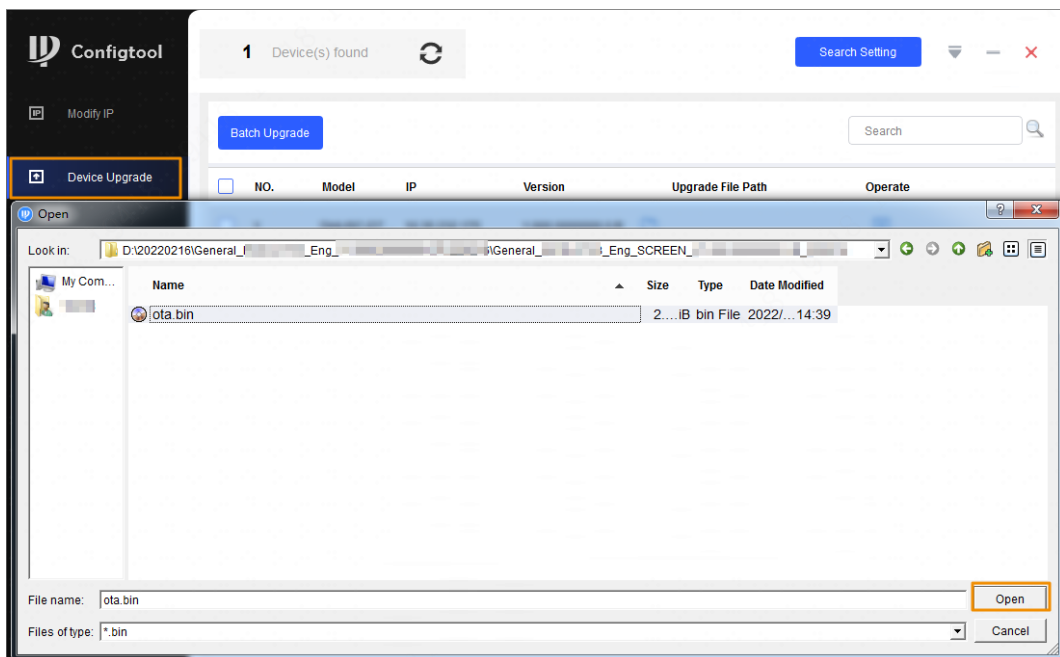
<input type="checkbox"/>	NO.	Model	IP	Version	Upgrade File Path	Operate
<input type="checkbox"/>	1	DHI-HSC-D7...	[REDACTED]	✓ [REDACTED]	D:/20220216/General_[REDACTED].	[REDACTED]

5. If you need to reset the Detector to factory default, see "4.11.2 Factory Reset", and then configure parameters.

7 FAQ

1. **Deal with the replaced spare parts.**

Contact our overseas maintenance points to check whether you need to send back the spare parts.

2. **The Detector cannot start.**

- a. Check whether the power is switched on.
- b. Check whether the power cable is loose or broken.
- c. Replace the host box.

3. **The screen cannot display content after the Detector starts.**

- a. Check whether the power is switched on.
- b. Check whether the cable between the door panel and the host box is properly connected.
- c. Check whether the cables in the host box are properly connected, and whether ribbon cables and probes are loose or broken.
- d. Replace the host box.

4. **The passed people cannot be counted. (The indicator light cannot work normally, or the Detector might alarm without people passing.)**

- a. Check whether the infrared start-stop mode is **Start both groups**; if not, select the mode to **Start both groups**.
- b. Enable **Start former group** or **Start latter group** separately to check which group cannot work normally.
- c. Check the problematic group through a camera of a phone with Android OS. Make the camera to the transmitting terminal (two ports) to check whether there is a red dot in the image. If there is no red dot in the image, the infrared sensor on the transmitting terminal cannot work normally, and you need to replace it.
- d. Remove the host and test it with the door panels that can work normally. If the problem still cannot be solved, replace the host box; otherwise, replace the door panel.

5. **There are false alarms.**

- a. Check whether the environment influences the detection rate of the Detector. For example, check whether there is direct light to the infrared sensors, and whether there are large metals within 1 meter's range.
- b. Adjust the frequency. To set the suitable frequency quickly, we recommend 3 levels for an adjustment. For example, when the current frequency is 3, adjust it to 6, and then check whether there are false alarms; if yes, adjust it to 9, and then check whether there are false alarms again. Repeat the operation until there is no false alarm..
- c. Adjust the security level lower.
- d. Replace the host detector for testing.
- e. If the problem still cannot be solved, replace the door panels.

6. **An alarm is not triggered when carry-on metal is passing.**

- a. Adjust the sensitivity of each zone higher.
- b. If the alarm is not triggered with the highest sensitivity, replace the host detector for testing.
- c. If the problem still cannot be solved, replace door panels.

7. **Alarm lights are not on.**

- a. Check whether the power supplies of host and door panel are normal.
- b. Check whether the ribbon cables of the alarm light are loose or broken.
- c. If the problem still cannot be solved, replace the host detector.

8. **No alarm is triggered in zones.**
 - a. Adjust the sensitivity value higher
 - b. Replace the host detector.
 - c. If the problem still cannot be solved, replace door panels.
9. **No alarm sound.**
 - a. Check whether the alarm sound is disabled.
 - b. Replace the speaker.
10. **There are big differences among the zone sensitivity values.**
 - a. Configure the sensitivity values according to the actual situation of each zone.
 - b. If the problem still cannot be solved, replace door panels.
11. **Buttons on the host box cannot work normally.**
 - a. Check whether buttons are in good contact.
 - b. If buttons are in good contact, replace the mainboard.
12. **The count result cannot be displayed.**
 - a. Check whether ribbon cables and probes of the display screen are loose or broken.
 - b. If the problem still cannot be solved, replace the host.
13. **The port cannot work normally.**
 - a. Check whether port cables are loose or broken.
 - b. Install the mainboard program again.
 - c. If the problem still cannot be solved, replace the related accessories.
14. **The network of host box is not connected successfully.**
 - a. Check whether the network cable is connected well, and whether the Detector IP and the default IP are in the same network segment.
 - b. Check whether the connection board and cable are connected well, or whether they are broken.
 - c. Install the mainboard program again.
 - d. If the problem still cannot be solved, replace the related accessories.
15. **The network of the thermal camera is not connected successfully.**
 - a. Check whether the network cable is connected well, and whether the Detector IP and the default IP are in the same network segment.
 - b. Check whether the connection board and cable are connected well, or whether they are broken.
 - c. Check whether the network indicator is on; if not, check whether the network cable is good, or whether the camera is power on.
 - d. If the problem still cannot be solved, replace the camera.
16. **The detected temperature cannot be displayed normally.**
 - a. Check the camera mount angle, and adjust it as needed.
 - b. Check whether the camera is connected to the Detector successfully.
 - c. Check whether the port cable is connected well, or whether it is broken.
 - d. Change the positions of the two terminals of the 485 cable.
 - e. Install the mainboard program again.
 - f. If the problem still cannot be solved, replace the camera.
17. **The temperature on the front forehead is recommended.**

The forehead temperatures of different people are different. With face mask covering the face, it is easy for the camera to monitor the forehead temperature; the highest temperature points are on the forehead, ears and neck, and the actual situation might vary according to different people. Make the camera monitor forehead temperature to reduce the influence from the temperature differences of different parts.

18. The recommended temperature conditions for temperature monitoring.

Indoor windless environment with the ambient temperature 10 °C to 30 °C.

19. Temperature monitoring and face detection function cannot work normally after correct configuration.

- a. The camera detects face with the visual channel by default. Check whether the problem is caused by back light, or weak light; if yes, enable WDR in visual channel or select thermal channel to monitor temperature.
- b. The camera has no license. Apply for the license.

20. There is missing detection for temperature monitoring.

- a. Faces cannot be detected in backlight or low illumination environment, so the temperature cannot be monitored. Enable WDR in backlight environment.
- b. Face filter angle is configured to small, and the camera cannot capture the face except front faces.
- c. Faces covered by helmets, hats or hands cannot be detected.

Figure 7-1 Enable WDR

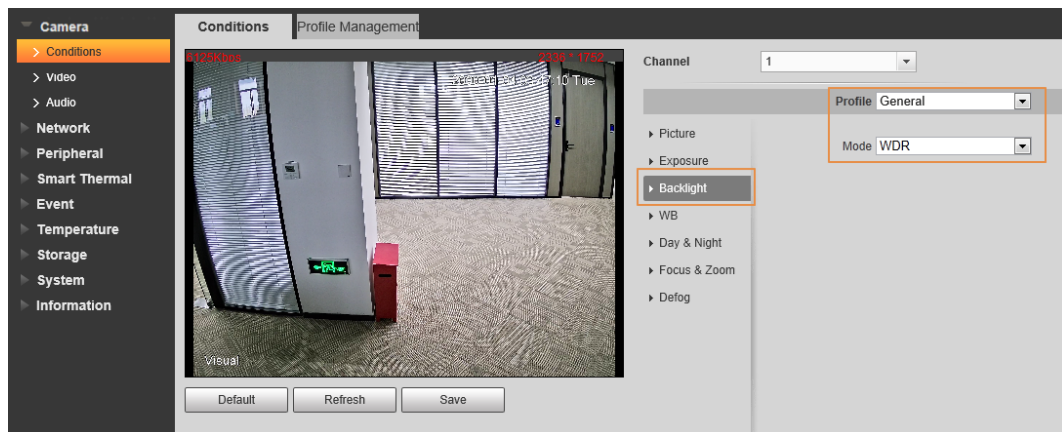

21. The bottom of the desktop displays



- a. No SLA battery is connected.
- b. No UPS board is connected or the UPS board is broken.

Appendix 1 Cybersecurity Recommendations

Mandatory actions to be taken for basic device network security:

1. Use Strong Passwords

Please refer to the following suggestions to set passwords:

- The length should not be less than 8 characters.
- Include at least two types of characters; character types include upper and lower case letters, numbers and symbols.
- Do not contain the account name or the account name in reverse order.
- Do not use continuous characters, such as 123, abc, etc.
- Do not use overlapped characters, such as 111, aaa, etc.

2. Update Firmware and Client Software in Time

- According to the standard procedure in Tech-industry, we recommend to keep your device (such as NVR, DVR, IP camera, etc.) firmware up-to-date to ensure the system is equipped with the latest security patches and fixes. When the device is connected to the public network, it is recommended to enable the **auto-check for updates** function to obtain timely information of firmware updates released by the manufacturer.
- We suggest that you download and use the latest version of client software.

"Nice to have" recommendations to improve your device network security:

1. Physical Protection

We suggest that you perform physical protection to device, especially storage devices. For example, place the device in a special computer room and cabinet, and implement well-done access control permission and key management to prevent unauthorized personnel from carrying out physical contacts such as damaging hardware, unauthorized connection of removable device (such as USB flash disk, serial port), etc.

2. Change Passwords Regularly

We suggest that you change passwords regularly to reduce the risk of being guessed or cracked.

3. Set and Update Passwords Reset Information Timely

The device supports password reset function. Please set up related information for password reset in time, including the end user's mailbox and password protection questions. If the information changes, please modify it in time. When setting password protection questions, it is suggested not to use those that can be easily guessed.

4. Enable Account Lock

The account lock feature is enabled by default, and we recommend you to keep it on to guarantee the account security. If an attacker attempts to log in with the wrong password several times, the corresponding account and the source IP address will be locked.

5. Change Default HTTP and Other Service Ports

We suggest you to change default HTTP and other service ports into any set of numbers between 1024–65535, reducing the risk of outsiders being able to guess which ports you are using.

6. Enable HTTPS

We suggest you to enable HTTPS, so that you visit Web service through a secure communication channel.

7. MAC Address Binding

We recommend you to bind the IP and MAC address of the gateway to the device, thus reducing the risk of ARP spoofing.

8. Assign Accounts and Privileges Reasonably

According to business and management requirements, reasonably add users and assign a minimum set of permissions to them.

9. Disable Unnecessary Services and Choose Secure Modes

If not needed, it is recommended to turn off some services such as SNMP, SMTP, UPnP, etc., to reduce risks.

If necessary, it is highly recommended that you use safe modes, including but not limited to the following services:

- SNMP: Choose SNMP v3, and set up strong encryption passwords and authentication passwords.
- SMTP: Choose TLS to access mailbox server.
- FTP: Choose SFTP, and set up strong passwords.
- AP hotspot: Choose WPA2-PSK encryption mode, and set up strong passwords.

10. Audio and Video Encrypted Transmission

If your audio and video data contents are very important or sensitive, we recommend that you use encrypted transmission function, to reduce the risk of audio and video data being stolen during transmission.

Reminder: encrypted transmission will cause some loss in transmission efficiency.

11. Secure Auditing

- Check online users: we suggest that you check online users regularly to see if the device is logged in without authorization.
- Check device log: By viewing the logs, you can know the IP addresses that were used to log in to your devices and their key operations.

12. Network Log

Due to the limited storage capacity of the device, the stored log is limited. If you need to save the log for a long time, it is recommended that you enable the network log function to ensure that the critical logs are synchronized to the network log server for tracing.

13. Construct a Safe Network Environment

In order to better ensure the safety of device and reduce potential cyber risks, we recommend:

- Disable the port mapping function of the router to avoid direct access to the intranet devices from external network.
- The network should be partitioned and isolated according to the actual network needs. If there are no communication requirements between two sub networks, it is suggested to use VLAN, network GAP and other technologies to partition the network, so as to achieve the network isolation effect.
- Establish the 802.1x access authentication system to reduce the risk of unauthorized access to private networks.
- Enable IP/MAC address filtering function to limit the range of hosts allowed to access the device.